

TEKTRONIX®

7D11

DIGITAL DELAY

SERVICE

INSTRUCTION MANUAL

Tektronix, Inc.
P.O. Box 500
Beaverton, Oregon 97005

Serial Number _____

WARRANTY

All TEKTRONIX instruments are warranted against defective materials and workmanship for one year. Any questions with respect to the warranty should be taken up with your TEKTRONIX Field Engineer or representative.

All requests for repair and replacement parts should be directed to the TEKTRONIX Field Office or representative in your area. This will assure you the fastest possible service. Please include the instrument Type Number or Part Number and Serial Number with all requests for parts or service.

Specifications and price change privileges reserved.

Copyright © 1973 by Tektronix, Inc., Beaverton, Oregon. Printed in the United States of America. All rights reserved. Contents of this publication may not be reproduced in any form without permission of Tektronix, Inc.

U.S.A. and Foreign TEKTRONIX products covered by U.S. and foreign patents and/or patents pending.

TEKTRONIX is a registered trademark of Tektronix, Inc.

TABLE OF CONTENTS

SECTION 1	OPERATING INFORMATION	Page
	7D11 FEATURES	1-1
	PRELIMINARY INFORMATION	1-1
	Installation	1-1
	Display	1-1
	CONTROLS AND CONNECTORS	1-3
	GENERAL OPERATING INFORMATION	1-3
	Signal Connection	1-3
	Count Mode	1-4
	Trigger Controls	1-4
	Triggered Light	1-4
	Trigger Coupling	1-4
	Trigger Source	1-5
	Trigger Slope/Level	1-5
	Events Start Trigger	1-5
	Delay Time or Events	1-5
	Fine Delay	1-5
	B Sweep Delay Mode	1-5
	OUTPUT SIGNALS	1-6
	Front Panel Output Signals	1-6
	Output Signals to Mainframe	1-6
	OPERATING MODES	1-7
	Sweep Delay	1-7
	Echo Delay Time Mode	1-7
SECTION 2	THEORY OF OPERATION	
	INTRODUCTION	2-1
	BLOCK DIAGRAM	2-1
	Time/Events Trigger	2-1
	Phase Lock Loop and Gated Countdown	2-1
	Outputs Processing and Events Start Trigger	2-1
	Delaying Counter and Display Generator	2-1
	Readout Encoding	2-1

TABLE OF CONTENTS (cont)







SECTION 2	THEORY OF OPERATION (cont)	Page
	THEORY OF OPERATION	2-2
	TRIGGER CIRCUITS 	2-2
	Trigger Preamp	2-2
	Trigger Generator	2-3
	PHASE LOCK LOOP AND GATED COUNTDOWN 	2-5
	Phase Lock Loop	2-5
	Fine Delay	2-6
	Gated Countdown	2-6
	OUTPUTS PROCESSING AND EVENTS	
	START TRIGGER 	2-9
	Time/Events Count Source Gate	2-9
	Delayed Trigger Output Flip-Flop	2-9
	Delayed Gate Flip-Flop	2-10
	Events Start Trigger	2-11
	DELAYING COUNTER AND DISPLAY GENERATOR 	2-11
	Voltage to Frequency Converter	2-11
	Reversible Counter and Nines Complement Review	2-12
	Delaying Counter	2-12
	Power-On Initializer	2-12
	Reset	2-13
	READOUT ENCODING 	2-13
	POWER DISTRIBUTION AND MAINFRAME	
	CONNECTOR 	2-13
	D.C. Inverter	2-14
	INTRODUCTION TO THE READOUT SYSTEM	2-14
	Introduction	2-14
	The Readout System	2-14
SECTION 3	MAINTENANCE	
	INTRODUCTION	3-1
	PREVENTIVE MAINTENANCE	3-1
	General	3-1
	Cleaning	3-1
	Lubrication	3-1
	Recalibration	3-1

TABLE OF CONTENTS (cont)

SECTION 3	MAINTENANCE (cont)	Page
	TROUBLESHOOTING	3-1
	General	3-1
	Troubleshooting Aids	3-1
	Troubleshooting Equipment	3-2
	Troubleshooting Procedure	3-2
	REPLACEMENT PARTS	3-3
	Standard Parts	3-3
	Transistor and Integrated Circuit Replacement	3-3
	Recalibration After Repair	3-3
	Special Parts	3-3
	Ordering Parts	3-3
	Repackaging for Shipment	3-3
SECTION 4	CALIBRATION	
	Calibration Interval	4-1
	Tektronix Field Service	4-1
	Using This Procedure	4-1
	TEST EQUIPMENT REQUIRED	4-1
	General	4-1
	Test Equipment Alternatives	4-1
	Signal Connections	4-1
	CALIBRATION PROCEDURE INTRODUCTION	4-4
	Index to Calibration Procedure	4-4
	Preliminary Procedure	4-5
	DIGITAL READOUT DISPLAY	4-6
	TRIGGERING	4-7
	EVENTS COUNT MODE	4-11
	TIME COUNT MODE	4-14
	OUTPUT SIGNALS	4-19
SECTION 5	ELECTRICAL PARTS LIST	
SECTION 6	DIAGRAMS	
SECTION 7	MECHANICAL PARTS LIST	
	CHANGE INFORMATION	

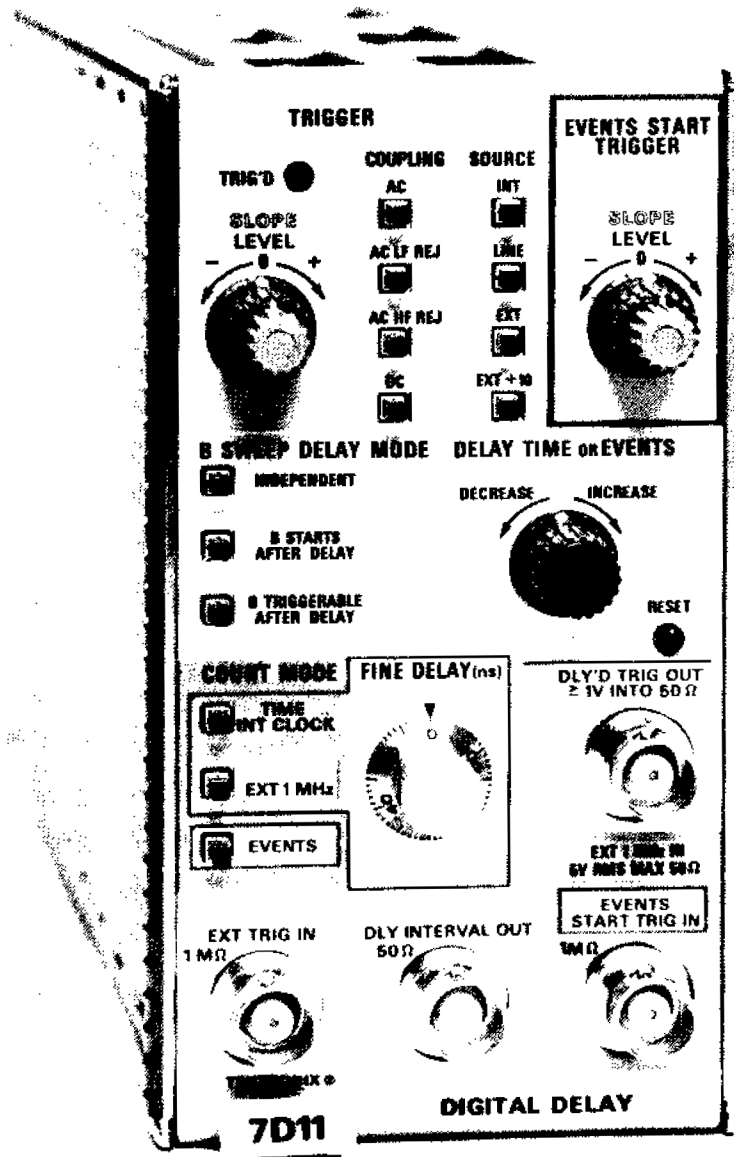

Fig. 1-1. 7D11 Digital Delay.

OPERATING INFORMATION

7D11 FEATURES

The 7D11 Digital Delay plug-in unit is designed for use with Tektronix 7000-series Oscilloscope mainframes equipped with a readout system. The 7D11 uses the readout system to display the selected delay count on the CRT. A delayed trigger output is generated by counting time or events. Digital delay time to one second is read out in 100-nanosecond increments. Additional analog delay time from zero to 100 nanoseconds selected from a calibrated front-panel dial provides added resolution. An "echo" time-delay mode provides a divide-by-two scaler to read out the "one-way trip" time, up to two seconds, for radar ranging and TDR applications. Delay time accuracy is controlled by an internal crystal oscillator; greater accuracy can be obtained by the use of an external one-megahertz standard. In the Count by Events mode, the CRT readout displays the integer number of events from one to 10^7 events at count rates up to 50 megahertz.

The 7D11 can be used to delay a 7B-series time-base unit in either a runs-after or triggerable-after delay time mode. Other 7D11 features include on-screen display of delay interval by vertical signal or display blanking, trigger pickoff from vertical amplifier unit, and blanking of the two leading zeros (count by time mode only).

PRELIMINARY INFORMATION

Installation

The 7D11 is designed to operate in any plug-in compartment of Tektronix 7000-series mainframes. However, certain modes of operation require the 7D11 to be installed in a specific compartment. The unit must be operated in a horizontal compartment to trigger from a signal applied to

a vertical amplifier unit. The 7D11 must be operated in the A Horizontal compartment to control the delay mode of a time-base unit in the B Horizontal compartment. Operation in a vertical compartment is necessary to view the Delay Interval Pedestal without the use of external cables.

To install the 7D11 into a plug-in compartment, push the unit in until it is seated flush against the front panel of the mainframe. To remove, pull the release latch to disengage the 7D11. Continue to pull the release latch to remove the unit from the mainframe.

Display

The 7D11 readout display is presented on the CRT of the mainframe, along with information encoded by the other plug-in units. Digital delay time (in milliseconds) is displayed in five to eight digits. The + symbol to the right of the digital display reminds the operator to add any analog delay time selected by the FINE DELAY (ns) dial to the delay time. The number of events being counted is presented in a seven to eight digit display.

The 7D11 readout display appears on the CRT in a location corresponding to the plug-in compartment used. The delay time or number of events will be displayed in the top division of the CRT graticule. The delay-time measurement unit (ms) will be displayed in the bottom division. It is not necessary to select the 7D11 with the mainframe Vertical or Horizontal Mode switches to view the digital display. In order to view the Delay Interval Pedestal waveform, selection with the Vertical Mode switch is required.

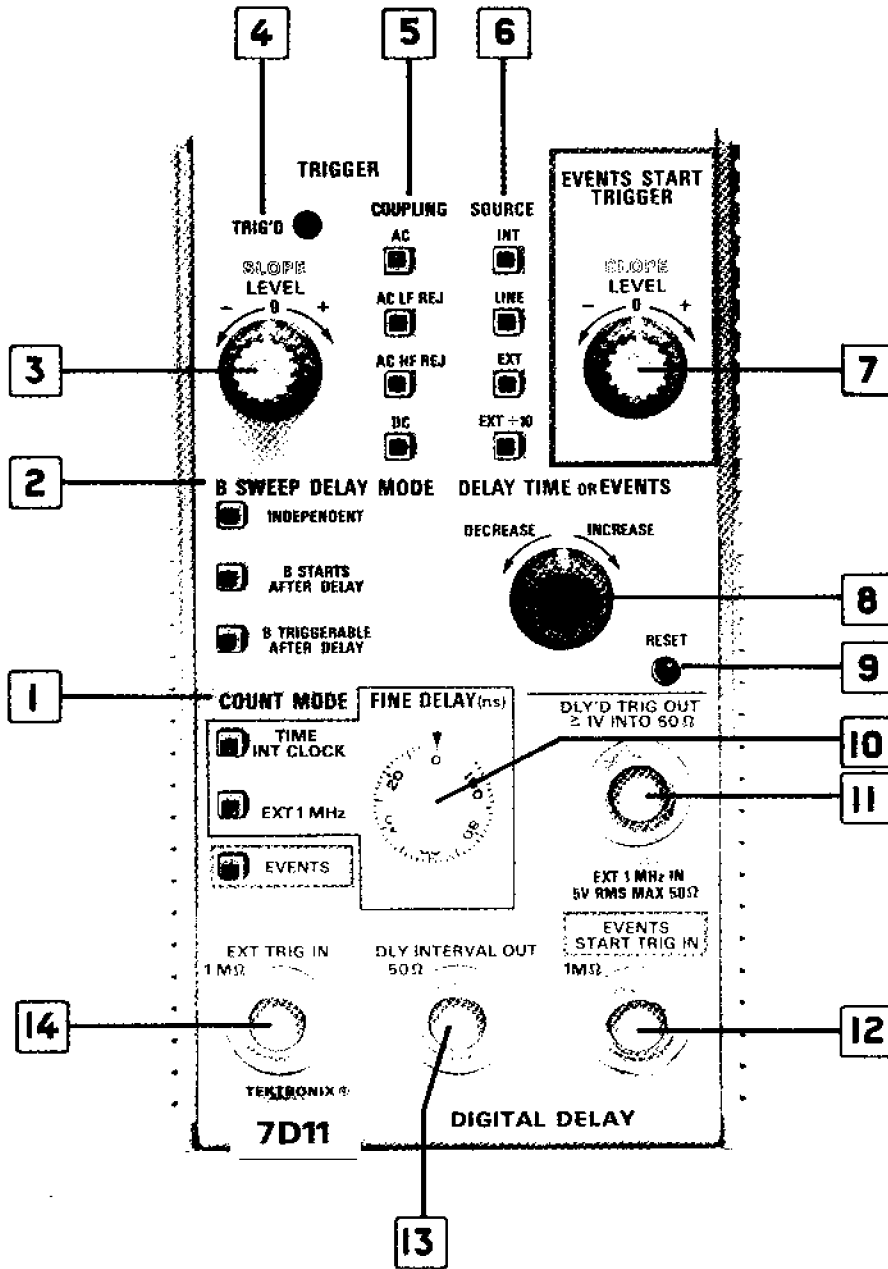

Fig. 1-2. 7D11 front-panel controls and connectors.

CONTROLS AND CONNECTORS

The major controls and connectors for operation of the 7D11 are located on the front panel of the unit. Two controls located inside the unit for auxiliary functions are described in the General Operating Information section. The front-panel controls and connectors are identified in Fig. 1-2; their functions are as follows:

- 1 **COUNT MODE Switch**
Selects mode of operation and clock-signal source for Time count mode.
- 2 **B SWEEP DELAY MODE Switch**
Selects the delay mode logic for time-base unit in B Horizontal compartment of mainframe.
- 3 **TRIGGER SLOPE/LEVEL Controls**
Select slope and amplitude point of input signal where the delay is initiated.
- 4 **TRIG'D Indicator**
Lights when a trigger is produced.
- 5 **COUPLING Switch**
Selects the method of coupling the input signal to the Trigger circuit.
- 6 **SOURCE Switch**
Selects Trigger input signal source.
- 7 **EVENTS START TRIGGER SLOPE/LEVEL Controls**
Select slope and amplitude point of input signal where the Events Start count is initiated.
- 8 **DELAY TIME OR EVENTS Control**
Selects delay time or number of events counted. Direction of rotation selects increase or decrease in delay time or number of events.
- 9 **RESET**
Resets the DELAY TIME or EVENTS to 0000001.
- 10 **FINE DELAY (ns) Dial**
Selects analog delay time added to digital delay time selected by DELAY TIME OR EVENTS control.

- 11 **DLY'D TRIG OUT**
BNC connector for Delayed Trigger output signal.
- 12 **EXT 1 MHz IN or EVENTS START TRIG IN**
BNC connector for input of external 1 MHz time-reference signal or input of Events Start Trigger input signal. Connector function is determined by setting of COUNT MODE switch.
- 13 **DLY INTERVAL OUT**
BNC connector for Delay Interval output signal.
- 14 **EXT TRIG IN**
BNC connector for external input to Trigger circuit (selected by SOURCE switch in the external positions).

GENERAL OPERATING INFORMATION

Signal Connection

In general, probes offer the most convenient means of connecting signals to the 7D11 external trigger inputs. Tektronix probes are shielded to prevent pickup of electrostatic interference. A 10X attenuation probe offers a high input impedance and allows the circuit under test to perform very close to normal operating conditions. Also, a 10X probe attenuates the input signal ten times.

Tektronix probes are designed to monitor the signal source with minimum circuit loading. The use of a probe will, however, limit the maximum trigger frequency range. To obtain maximum trigger bandwidth when using probes, select a probe capable of compensating the input capacitance; observe the grounding considerations given in the probe manual. The probe-to-connector adapters and the bayonet-ground tip provide the best frequency response.

In high-frequency applications, requiring maximum overall bandwidth, use a coaxial cable terminated at both ends in the characteristic impedance of the cable. To maintain the high-frequency characteristics of the applied signal, use high-quality low-loss cable. Resistive coaxial attenuators can be used to minimize reflection if the applied signal has suitable amplitude.

High-level, low-frequency signals can be connected directly to the external trigger inputs with short, unshielded leads. When this method is used, establish a common ground between the 7D11 and the associated equipment. The common ground provided by the line cords is usually inadequate. If interference is excessive with unshielded leads, use a coaxial cable or probe.

Operating Information—7D11 Service

A signal can also be routed to the 7D11 through an amplifier unit via the internal trigger circuitry of the mainframe (7D11 installed in a horizontal compartment). This method of signal connection minimizes circuit loading, especially when triggering a time-base unit in parallel with the 7D11.

NOTE

Only external signals can be used with the Events Start Trigger.

The front-panel output signals, DLY'D TRIG OUT and DLY INTERVAL OUT, should be connected to other equipment with 50-ohm coaxial cables. The cables should be terminated in 50 ohms to maintain the rise and falltime characteristics of these signals.

Count Mode

General. Two basic count modes, Time and Events, can be performed by the 7D11, as selected by the COUNT MODE switch. The delay interval in both modes is selected by the DELAY TIME OR EVENTS control and is read out on the CRT.

TIME INT CLOCK. The 7D11 counts precise increments of time after the receipt of a trigger. The TRIGGER controls select and condition the signal to start the time delay. Accuracy in this mode is determined by an internal, crystal-controlled oscillator.

TIME EXT 1 MHz. This count mode is the same as TIME INT CLOCK except the accuracy is derived from an external, one-megahertz standard.

EVENTS. The 7D11 counts events, periodic or aperiodic, at count rates to 50 megahertz. The EVENTS START TRIGGER provides a means of discriminating between the event that starts the delay and the events to be counted. The events to be counted are selected and conditioned by the TRIGGER controls.

Trigger Controls

The input signal may have a wide variety of shapes and amplitudes, many of which are unsuitable as delay-initiating triggers. For this reason, these signals are first applied to a trigger circuit where they are converted to pulses of uniform amplitude and shape. This makes it possible to start the delay with a pulse that has a constant size, eliminating variations of the delay circuit operation caused by changing input signals. The TRIGGER controls provide a means to select the signal source, filter unwanted frequencies, and start the delay at any voltage level on either slope of the waveform.

Triggered Light

The TRIG'D light provides a convenient indication of the Trigger circuit condition. If the TRIGGER controls are correctly set and an adequate signal is applied, the TRIG'D light is on. If the TRIG'D light is off, no delay interval is started. The cause might be an incorrectly set TRIGGER control, low signal amplitude, or a signal repetition rate outside the usable frequency range. This feature can be used as a general indication of correct triggering when there is no display on the CRT. The Delay Interval Pedestal and Z-Axis Blanking displays also aid in obtaining correct TRIGGER control settings. See the discussion of these features under Output Signals to Mainframe for further information.

NOTE

When the 7D11 is used in the EVENTS count mode, the EVENTS START TRIGGER affects the output of the Trigger circuit but has no effect on the TRIG'D light.

Trigger Coupling

The TRIGGER pushbuttons located below the COUPLING title select the method in which the input signal is connected to the Trigger circuit. Each position permits selection or rejection of various frequency components of the signal used to trigger the delay start.

AC. In this position of the COUPLING switch, the DC component of the input signal is blocked. Signals with low-frequency components below about 30 hertz are attenuated. In general, AC COUPLING can be used for most applications. However, if the signal contains unwanted frequency components or if the delay is to be triggered at a low repetition rate or DC level, one of the other switch positions will provide better results.

The triggering point in the AC position depends upon the average voltage level of the input signal. If the input signal occurs randomly, the average voltage level will vary, causing the triggering point to vary also. This shift of the triggering point may be enough so it is impossible to maintain a stable delay start; in such cases, use DC coupling.

AC LF REJ. In this position, DC is rejected and low-frequency input signals below about 30 kilohertz are attenuated. Therefore, the delay is triggered only by the higher-frequency components of the input signal. The AC LF REJ position is particularly useful for providing stable triggering if the input signal contains line-frequency components.

AC HF REJ. This COUPLING switch position passes all low-frequency signals between about 30 hertz and 50 kilohertz. DC is rejected and signals above 50 kilohertz are attenuated. This position is useful to trigger the delay from the low-frequency components of a complex waveform.

DC. The DC position can be used to provide stable triggering from low-frequency or low-repetition-rate signals which would be attenuated in other modes. It can also be used to trigger the delay when the input signal reaches a DC level selected by the setting of the SLOPE/LEVEL control. When triggering from the internal source, the setting of the vertical unit position control(s) affects the DC triggering point.

Trigger Source

The TRIGGER pushbuttons located below the SOURCE title select the source of the signal connected to the Trigger circuit.

INT. In this position, the input signal is derived from the associated vertical unit. Therefore, the 7D11 must be installed in a horizontal compartment to use the internal source. Further selection of the internal signal may be provided by the vertical unit and mainframe; see the instruction manuals for these instruments for further information.

LINE. In this SOURCE switch position, a sample of the power-line voltage from the mainframe is connected to the Trigger circuit. Line triggering is useful when the input signal is time related (multiple or submultiple) to the line frequency. It is also useful for providing stable triggering from a line-frequency component in a complex waveform.

EXT. A signal connected to the EXT TRIG IN connector can be used to trigger the delay in the EXT position of the SOURCE switch. An external signal can be used to provide a trigger when the internal signal amplitude is too low.

EXT ÷ 10. Operation in this position is the same as described for EXT except the external signal is attenuated 10 times. Attenuation of high-amplitude signals is desirable to extend the range of the LEVEL control.

Trigger Slope/Level

The TRIGGER SLOPE/LEVEL controls determine the slope and voltage level of the input signal where the Trigger circuit responds. Generally, the best point on a waveform for triggering the delay is where the slope is steep, and therefore usually free of noise. Assuming a sine-wave input waveform, the steepest slope occurs at the zero-crossing point. This is the point selected for triggering when the LEVEL control is set to 0 (center). A more positive or negative point on the waveform is selected as the LEVEL control is rotated clockwise or counterclockwise respectively from 0 (toward + or – symbols on panel).

Before setting the TRIGGER LEVEL, the desired SLOPE, MODE, COUPLING, and SOURCE should be selected. Then adjust the LEVEL control so the delay starts from the desired point.

Events Start Trigger

The Events Start Trigger is used in the EVENTS count mode to differentiate between the event that starts the delay and the events being counted.

The EVENTS START TRIG IN connector provides the input to the events-start signal. The EVENTS START TRIGGER SLOPE and LEVEL controls select the amplitude point and slope on the input signal where the delay is triggered.

Delay Time or Events

The DELAY TIME OR EVENTS control selects the digital delay time in the TIME count mode, and the number of events counted in the EVENTS count mode. The delay time in milliseconds, or integer number of events, selected is displayed on the CRT readout.

This control is a spring-return-to-center control that increases or decreases the count at which a delayed pulse will occur. The direction of rotation determines whether the count is increased or decreased. The rate at which the count increments is determined by the magnitude of rotation. After either extreme of the range is reached, the next count starts from the other end of the range. For example, if the delay time is increased above 1000.0000 ms (one second), the count will go to 0.0001 ms. Conversely, if the delay time is decreased past 0.0001 ms, the count will go to 1000.0000 ms.

Fine Delay

The FINE DELAY (ns) dial selects analog delay time from zero to 100 nanoseconds in the TIME count mode. This one-turn control provides added resolution to the digital delay time selected by the DELAY TIME OR EVENTS control. The delay time selected by the FINE DELAY (ns) dial is read from the calibrated knob as the analog delay time is not read out on the CRT. Each minor division on the dial represents two nanoseconds.

B Sweep Delay Mode

The B SWEEP DELAY MODE switch permits the 7D11, under specific conditions, to select the delay mode of a compatible time-base unit. To use this feature, the 7D11 is installed in the A Horizontal compartment and the time-base in the B Horizontal compartment of a four-plug-in mainframe. With this arrangement, the time-base unit can be controlled through the mainframe interface. Some dual time-base units are not compatible with this feature; see the time-base unit instruction manual for further information.

INDEPENDENT. The 7D11 and the time-base unit operate independently.

B STARTS AFTER DELAY. The time-base unit produces a sweep immediately following the selected delay interval. This provides the same mode of operation as triggering the time-base unit with the delayed trigger output.

B TRIGGERABLE AFTER DELAY. The time-base unit produces a sweep after the first trigger pulse is received following the selected delay interval. This mode of operation provides a stable display of a signal having time jitter. Precision time measurements cannot be made in this mode because the actual delay time is only partially dependent on the delay interval of the 7D11.

OUTPUT SIGNALS

Front-Panel Output Signals

General. The Delay Interval and Delayed Trigger outputs are available at the front-panel DLY INTERVAL OUT and DLY'D TRIG OUT connectors respectively. These outputs can be used to control other equipment during or immediately following the delay interval. To maintain the rise and falltime characteristics of these signals, connection to other equipment should be made with 50-ohm coaxial cable; the output of the cable should be terminated in 50 ohms.

DLY INTERVAL OUT. This output is a positive-going, rectangular waveform coincident with the generated delay interval. In the time mode, the DLY INTERVAL OUT is approximately 20-30 nanoseconds shorter than the indicated delay time because of internal propagation delays and trigger recognition time. In the event mode, the DLY INTERVAL OUT is within 30 nanoseconds of actual delay, usually 10 nanoseconds.

DLY'D TRIG OUT. This signal is generated as a positive-going rectangular pulse coincident with the end of the delay interval.

The front-panel output signals are shown in Fig. 1-3, along with the input signal. The input signal, Fig. 1-3(A), is comprised of one- and ten-microsecond time markers. The

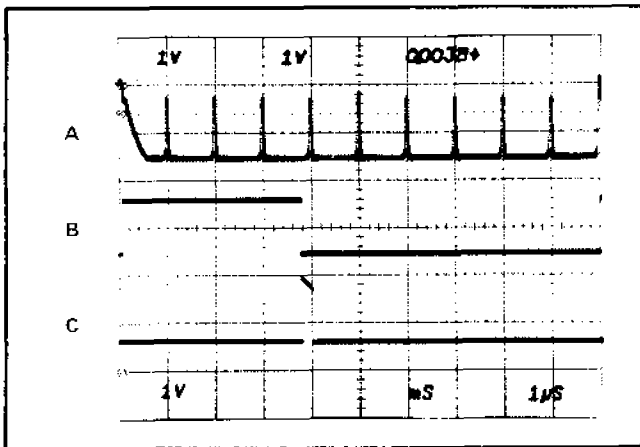

Fig. 1-3. Display showing time relationship of: (A) Input signal to the front panel; (B) Delay Interval; and (C) Delayed Trigger outputs.

7D11 is set for a 0.0038-millisecond delay time after triggering on the ten-microsecond markers. The resultant Delay Interval and Delayed Trigger outputs are shown in Fig. 1-3(B) and (C), respectively.

Output Signals to Mainframe

General. Signal outputs are provided to the mainframe via the interface connector. The following discussion describes these signals and the operating conditions necessary for their use.

Delay-Interval Pedestal. This output provides an on-screen display of the approximate delay interval. To view the pedestal display, the 7D11 must be installed in a vertical plug-in compartment and be selected by the mainframe Vertical Mode switch. The position of this display is fixed near the vertical center of the graticule area. The Delay-Interval Pedestal display is shown in Fig. 1-4(A). The input signal, shown in Fig. 1-4(B), is comprised of one- and ten-microsecond time markers. The 7D11 is set to trigger on the ten-microsecond markers, and to generate a 0.0038-millisecond delay time.

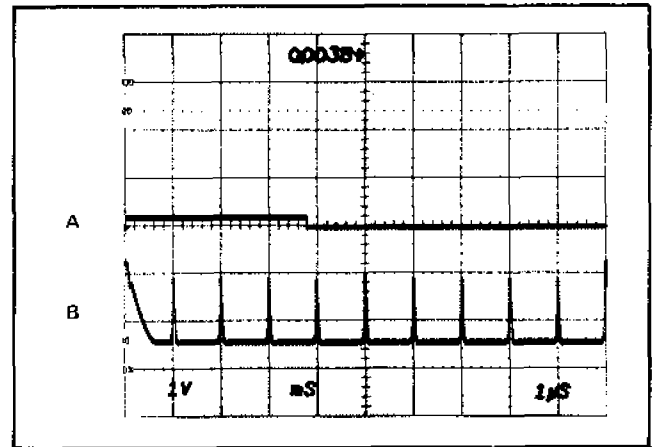

Fig. 1-4. Waveform display of: (A) Delay Interval Pedestal; (B) input signal.

Delayed Trigger. The Delayed Trigger output provides an internal Delayed Trigger source for a time-base unit. A time-base unit can be triggered from the Delay Trigger when the 7D11 is in a vertical compartment. To use this output, the 7D11 must be selected by the appropriate trigger source switch (mainframe).

Z-Axis Blanking. Z-axis blanking provides an on-screen display of the approximate delay interval. This is accomplished by blanking out the CRT display during the delay interval. Z-axis blanking can be obtained with the 7D11 installed in any plug in compartment. The Z-axis blanking display is selected by a slide switch located inside the unit (on the left side; see Fig. 1-5).

NOTE

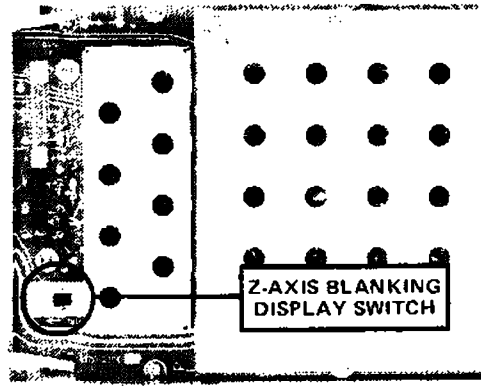

Fig. 1-5. Location of Z-Axis Blanking Display switch (on left side of instrument). The switch position towards the rear of the unit selects Z-axis blanking.

NOTE

At faster sweep speeds (100 ns/div or faster) care must be taken when interpreting CRT display because relative propagation delays through the 7D11 and vertical amplifier plug-ins are not the same. This appears as a relative time shift between delay interval pedestal or Z-axis blanking generated by the 7D11 and the signal(s) viewed through a vertical amplifier on the CRT. Changing the TRIG SOURCE between INT and EXT or $EXT \div 10$ will vary this apparent time shift due to differences in propagation delays of the signal path.

OPERATING MODES

Sweep Delay

The 7D11 can be used to delay the start of a sweep for a selected time interval following the receipt of a trigger. Low-jitter sweep delay can be used for accurate time, jitter, and stability measurements. Sweep delay can also be used to select a portion of a complex signal for display. A sweep is delayed by triggering the sweep from the Delayed Trigger output of the 7D11, rather than from the signal to be displayed. Several methods of coupling the Delayed Trigger to the sweep are possible, depending on the application. These methods are described in the following discussions.

B Sweep Delay Mode Switch. The sweep produced by a time-base unit can be controlled and delayed by a 7D11 via the mainframe interface and the B SWEEP DELAY MODE switch. To use this mode of sweep delay, the 7D11 must be installed in the A Horizontal compartment and the time-base unit in the B Horizontal compartment of a four-plug-in mainframe. For further information, see B Sweep Delay Mode.

The logic levels provided to the 7D11 from the mainframe are designed to control a time-base unit delaying sweep. For this reason, the 7D11 might become locked out (no output) when the setting of either the B-Sweep unit Time/Division switch or the B SWEEP DELAY MODE switch is changed. If this occurs, a delayed sweep will not be produced. To reset the 7D11, set the B SWEEP DELAY MODE switch first to INDEPENDENT, then select the desired delay mode.

Internal Trigger. The sweep produced by a time-base unit in a horizontal compartment can be internally triggered from a 7D11 in a vertical compartment. To use this sweep delay mode, the 7D11 must be selected by the mainframe trigger source switch. Delaying a time-base sweep from the internal source can be used with the units installed in either a three- or four-plug in mainframe.

External Trigger Source. A sweep can be delayed by external triggering from the DLY'D TRIG OUT connector. This method can be used with any triggered sweep.

Echo Delay Time Mode

The Echo delay time mode provides a CRT readout of the "one-way-trip" time, or one-half of the generated delay time. This mode of operation is selected for use by an internal switch (on left side of unit, see Fig. 1-6). In the Echo mode, the delay time is selected by the DELAY TIME OR EVENTS control in 200-nanosecond increments. An insertion delay of about 160 nanoseconds in this mode requires adding analog delay time to the first delay increment to obtain a 200-nanosecond delay interval. This can be accomplished by displaying the DELAY INTERVAL OUT and setting the FINE DELAY dial for a total delay interval of 200 nanoseconds as measured on the graticule.

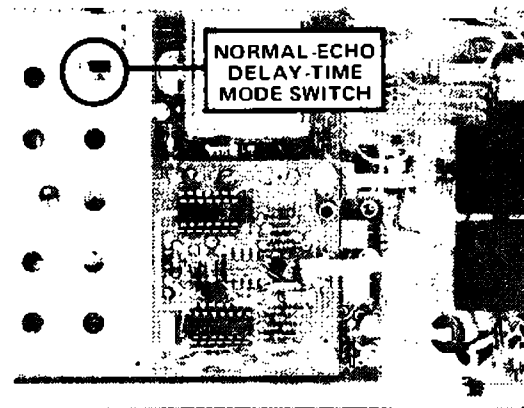

Fig. 1-6. Location of Normal-Echo Delay Time Mode switch (on left side of unit). Set the switch towards the front of the unit to select Normal Mode.

THEORY OF OPERATION

INTRODUCTION

This section provides a general, block diagram description of the 7D11. This is followed by the theory of operation which is keyed to the schematic diagrams of the circuits described. If more information is desired on commonly used circuits, refer to the following textbook:

Jacob Millman and Herbert Taub, "Pulse, Digital, and Switching Waveforms", McGraw-Hill, New York, 1965.

Following the theory of operation is a brief discussion of the readout system used in Tektronix 7000-series Oscilloscopes. If more information is required on the readout system, refer to the instruction manual for the oscilloscope.

BLOCK DIAGRAM

The block diagram is divided into the following five main sections: Time/Events Trigger, Phase Lock Loop and Gated Countdown, Outputs Processing and Events Start Trigger, Delaying Counter and Display Generator, and Readout Encoding.

Time/Events Trigger

The Time/Events Trigger circuit processes the trigger signal for starting the delay by time count through the Phase Lock Loop and Gated Countdown circuit when in the delay by time mode. In the delay by events mode the trigger circuit provides the actual count signal, derived from the signal selected by the SOURCE and COUPLING switches.

Phase Lock Loop and Gated Countdown

The Phase Lock Loop and Gated Countdown block consists of two main sections. One section is the phase lock loop that supplies a stable 500-megahertz clock, phase locked to an internal five-megahertz crystal or to an external one-megahertz reference. The second section consists of the fine delay and gated countdown circuits. When a trigger is received from the trigger section, it is routed through the Fine Time Delay Multi-stage where it is delayed an additional amount, determined by the front panel control, to the Time Count Switch. Once the Time Count Switch is opened, it allows the 500-megahertz clock to be divided down to 10 megahertz. This 10-megahertz signal is then presented to the Time/Events Count Source Gate in the Outputs processing and Events Start Trigger section.

Outputs Processing and Events Start Trigger

The Outputs Processing and Events Start Trigger section performs several internal and reset functions in addition to providing the various outputs of the 7D11. This circuit provides B sweep delay, Z-axis intensification during the delay interval, the delay interval out pedestal, and the delayed trigger output. This circuit also contains the Events Start Trigger, which allows counting of events trigger in the delay by events mode.

Delaying Counter and Display Generator

The Delaying Counter and Display Generator section provides the circuitry for setting up the delay by time or delay by events count. The delay is set up as the nine's complement of the delay count in the Reversible Counter by the DELAY TIME OR EVENTS CONTROL and is counted by the Delaying Counter. The Delaying Counter counts time from 100 nanoseconds to one second or counts events to 10,000,000. When the preset delay count is completed (the count signal to the Delaying Counter comes from the Time/Events Count Source Gate on block 3), the Nines Arm Gate activates the Output Release Gate on block 3. This simultaneously ends the DLY INTERVAL OUT and activates the DLY'D TRIGGER OUT.

Readout Encoding

The delay time or events setting is encoded by the Readout Encoding section. These circuits provide necessary information to the readout system in the associated mainframe to allow the delay time or events count to be displayed on the CRT.

THEORY OF OPERATION

The following theory of operation discussion is referenced to the schematic diagrams in the diagram section of this manual. Each main topic heading is followed by the number of the schematic to which it applies.

TRIGGER CIRCUITS

The trigger circuit consists of two main sections, the *trigger preamp* and the *trigger generator*.

Trigger Preamp

The trigger preamp serves to select trigger source and coupling for the trigger generator. This circuit may be considered as consisting of the following four elements: Trigger Source Switching, U60; External Trigger Preamp or external input amplifier, Q32, Q37, and Q41; Balanced-to-Single-Ended Converter, Q71, Q75, and Q78; and Trigger Coupling, Q82, Q84, and Q86.

Trigger Source Switching. U60 receives internal trigger inputs at pins 2 and 15 and external trigger signals at pin 7. U60 determines which input signal is selected by means of a digital signal (voltage level) at pin 4. A LO on pin 4 activates pins 2 and 15 for internal triggering, while a HI on pin 4 switches U60 to activate pins 7 and 10 for external triggering.

To further examine U60, assume that pin 4 is low, activating pins 2 and 15 for internal triggering. This input is a relatively high impedance differential configuration. Pin 15 receives the positive-going trigger signal and pin 2 is the negative-going input. The inputs are biased at the center of their dynamic range and signal limiting in the trigger pickoff circuitry (in the indicator oscilloscope) ensures that the inputs will not be driven into cutoff or saturation. R55 and R57 terminate the internal trigger signal from the indicator oscilloscope. The analog current source for internal triggering is through pins 1 and 16.

The switch output current appears at pins 12 and 13. A positive-going signal at pin 15 will cause an increase in current into pin 13 and out through pin 16, R66, and R69. Simultaneously, the negative-going signal at pin 2 causes a decrease in current into pin 12 and out through pin 1, R68, and R69. The net result is that the total current through pins 12 and 13 and through R69 remains constant.

External Trigger Preamp. This circuit includes Q32, Q37 and Q41. The SOURCE switch (S5) at the input selects internal, external, or line signals for triggering. The external trigger signal may be attenuated to one-tenth amplitude by

selecting EXT ÷ 10. R6 and R7 (paralleled by R30) form a 10:1 attenuator.

The input impedance for the trigger input is one megohm, consisting primarily of R12 and R30. This resistor pair also causes a 2X attenuation of the input signal as seen at the gate of Q32 A and B. C24 serves to compensate the input stage and C10 compensates the 10X attenuator.

CR27 and CR28 protect Q32 from excessive input signal by clamping the gate if the signal at the input connector exceeds approximately plus or minus 2.5 volts. The signal at the source of Q32 is coupled through emitter follower Q37 to the base of Q41. Q41 is another emitter follower, which drives U60. The signal at pin 7 of U60 is terminated in approximately 50 ohms by R46 to preserve the high-frequency characteristics.

R49 sets the DC level at pin 10 of U60, which is the negative side of the external trigger differential input. This serves to match the DC balance of the external trigger input of U60 to that of the internal trigger input.

Balanced-To-Single-Ended Converter. Q71, Q78, and Q75 convert the balanced (push-pull) output of U60 to a single-ended signal at the emitter of Q75.

The trigger signal through U60 causes a decrease in current into pin 12 from R77 and R78 and an increase in current into pin 13 from R71. This would normally cause the voltage at pin 12 to swing in a positive direction, while pin 13 goes in a negative direction. However, the current through R77 and R78 actually increases due to the feedback via R79 and Q78, causing the voltage at pin 12 to swing negative along with pin 13. Q78 is connected as a diode and is enclosed in the same heat-sink with Q71, providing good DC stability.

Trigger Coupling. When DC coupling is selected by the front panel COUPLING switch, Q86 is turned on by the +15 volt supply through R92, S95, and R86 to its base. The triggering signal is then coupled through R80 and Q86 to the base of Q100.

Q84 is turned on when AC coupling is selected. The triggering signal then passes through Q84 and C87 to the base of Q100. For AC LF REJ coupling, Q84 is off and the triggering signal is coupled through C88 and C87 to attenuate low frequency signals.

For AC HF REJ coupling, both Q84 and Q82 are turned on. The high-frequency components are coupled through

Q82 and C83 to ground, while the desired triggering component is coupled through Q84 and C87 (as in AC coupling).

Trigger Generator

The trigger generator consists of the Slope Selector and Level Comparator, Trigger Tunnel Diode and Driver, Triggered Lamp multi, TRIG'D Lamp Driver, Trigger Generator Count Interval Schmitt, Events Schmitt, and Events and Count Coincident Gate.

Slope Selector and Level Comparator. This stage comprises Q100, Q102, Q117, Q121 and Q124. Q100 and Q102 are connected as a differential comparator. The reference voltage for the comparator is selected by the setting of the LEVEL control, R111. The internal DC Balance adjustment, R77, sets the level at the base of Q100 so that the delaying counter is triggered at the zero-volt point of the incoming trigger when the LEVEL control is set to the center of the positive or negative slope region. The LEVEL control varies the voltage on the base of Q102 to select the point on the trigger signal where triggering occurs.

R104 establishes the emitter current for Q100 and Q102. Prior to the arrival of a trigger signal, with the LEVEL control set to the center of the positive or negative slope, Q100 and Q102 are passing equal currents.

Assume that a positive-going signal is applied to the EXT TRIG IN connector and that the LEVEL/SLOPE control is set to zero on the positive slope.

The signal at the EXT TRIG IN connector is inverted by the trigger preamp, appearing at the base of Q100 as a negative-going signal. This will cause a decrease in current through Q100, and because of the common emitter source, R104, the current through Q102 will increase. The decreased collector current of Q100 biases Q121 in a reverse direction, while Q117 becomes more forward biased due to the increased current through Q102.

With the SLOPE switch (S2) in the + position, the cathode of CR126 is grounded, forward biasing CR126, which reverse biases CR129. At the same time, the base of Q124 is at ground and Q124 is off. This causes CR122 to be reverse biased and CR128 is forward biased through Q117. An increased current is applied through Q117 and CR128 to the trigger tunnel diode and driver circuit (see Fig. 2-1).

When the SLOPE switch is set to the - position, Q124 and CR122 are forward biased and CR128 is reverse biased.

CR126 is reverse biased and CR129 is forward biased so that current flows through Q121 and CR129 to the trigger tunnel diode and driver circuit.

Trigger Tunnel Diode and Driver. The trigger tunnel diode stage shapes the output of the comparator to provide a trigger pulse with a fast leading edge.

Tunnel diode CR141 is quiescently biased so that it is in its low-voltage state. Increased trigger current from Q117 and CR128 or Q121 and CR129 through R130, L130, and CR141 causes CR141 to switch to the high-voltage state. The resulting fast-rise positive step is coupled through emitter-follower Q143 to C182, C145, and C166 in the auto multi and trigger generator circuits.

Trig'd Lamp Multi. The Trig'd Lamp Multi stage includes Q183 and Q188. When no trigger is applied, Q183 is off and C185 is charged to a positive level (at the collector of Q183) determined by R184, R190, and R191. The base of Q192 is more positive than the base of Q194, so Q194 is conducting.

When a trigger is applied, Q183 and Q188 operate as an emitter-coupled monostable multi. Q183 is momentarily turned on by the positive transition coupled through C182.

The collector of Q183 drops and C185 discharges through R185, turning off Q188. This holds Q183 on for a period determined by the charging time-constant of C185. If the trigger signal has a repetition rate of 20-hertz or greater, Q183 stays on (see Fig. 2-2). With Q183 on, Q192 is also conducting and Q194 is off.

TRIG'D Lamp Driver. During the time that Q183 is on, the increased drop across R184 forward biases Q192. This turns on Q198, which drives the TRIG'D lamp, DS197.

Trigger Generator. The trigger generator includes Q149, Q159, CR169, and CR171. The function of this circuit is to supply a fast-rise trigger signal to the Count Interval Schmitt. For normal triggering, this signal is developed after receipt of a fast-rise transition from the trigger tunnel diode and driver stage, except during holdoff.

For the following discussion of operation, assume that a trigger signal is applied to the EXT TRIG IN connector.

The positive-going transition at the emitter of Q143 is coupled through C182, causing the TRIG'D lamp, DS197 to be energized as previously described.

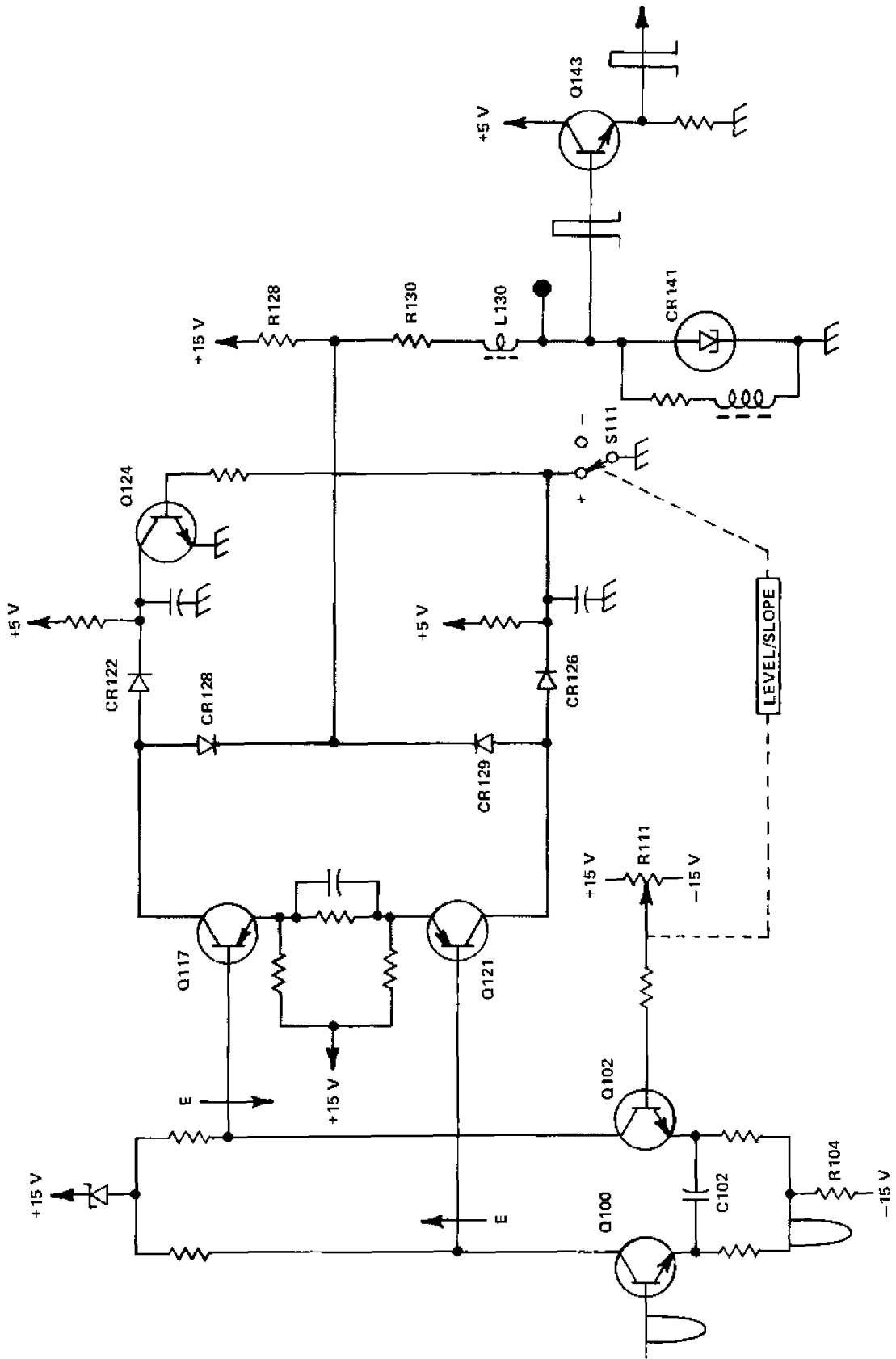

Fig. 2-1. Trigger current path for positive slope triggering.

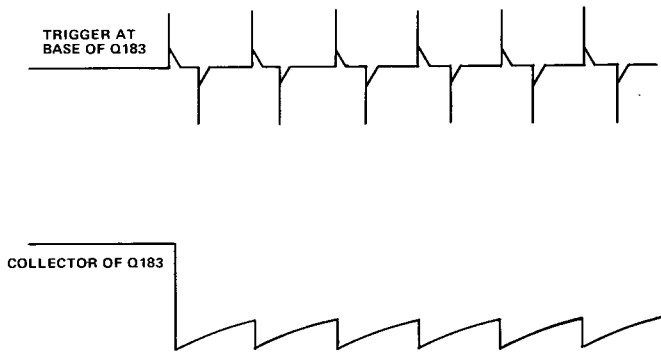

Fig. 2-2. Auto Multi input and output waveforms with trigger signal applied.

CR169 and CR171 are both in their high states until the holdoff signal switches them to the low state. The holdoff signal is a positive pulse which forward biases both Q149 and Q159. When these transistors are forward biased, they divert current from CR171 and CR169, which causes the tunnel diodes to switch to their low states.

The next trigger after holdoff appears as a positive transition at C145 and C166. The positive transition, coupled through R166 and R168 causes CR169 to switch to its high state. This higher level, through R170, brings CR171 up to near its switching current. The positive transition is also coupled through C145 and R145; and, after 3.5 nanoseconds of delay, through R154 and CR171. The short delay ensures that CR169 has had time to switch to its high state, arming CR171 before arrival of the switching signal at CR171. This prevents extraneous noise from prematurely activating CR171. CR171 then switches to its high state.

The fast rise positive trigger from CR171 is coupled to the base of Q351 of the fine delay circuit through Q173.

Events Count Mode. The signal output of CR141 is used for events counting. The output of CR141 is coupled

through a level shifting Schmitt trigger, Q133 and Q138, to an input to U640D. To ensure that events are counted only when holdoff is not present, the output of CR171 is also coupled to an input to U640D through the level shifting Schmitt trigger formed by Q173 and Q178. Therefore, U640D is enabled, during the absence of holdoff, to output the events count pulses to Q512, the Events Count Source Gate.

PHASE LOCK LOOP AND GATED COUNTDOWN 2

The phase lock loop and gated countdown circuits provide the very accurate time count for the 7D11. In addition to supplying the timing signal, this circuitry also provides the fine delay.

Phase Lock Loop

The phase lock loop is a method of generating a frequency that is some multiple of an incoming (reference) frequency. The $\div n$ counter divides the local VCO frequency by some integral number, n . The phase detector compares the phase of an incoming signal (see Fig. 2-3) with that of the divided down local voltage controlled oscillator (VCO) and generates a voltage proportional to the phase difference. This voltage is then filtered to remove ripple at the frequency of phase detection and is applied to the voltage controlled oscillator to correct any phase difference. Phase lock is established when the reference and divided down VCO frequencies are constant in phase shift. The local oscillator frequency is then an exact multiple (n) of the reference with the same stability characteristics.

Y200 is a five-megahertz crystal-controlled oscillator. Its output is routed through U205, where it is divided by five and presented to count mode switch S210 as a one-megahertz signal for internal timing. If external timing is selected, the external one-megahertz signal is processed through Q225 and Q227 to S210. The one-megahertz signal is then routed from S210 to Phase Detector U230 where it is compared with the one-megahertz frequency derived

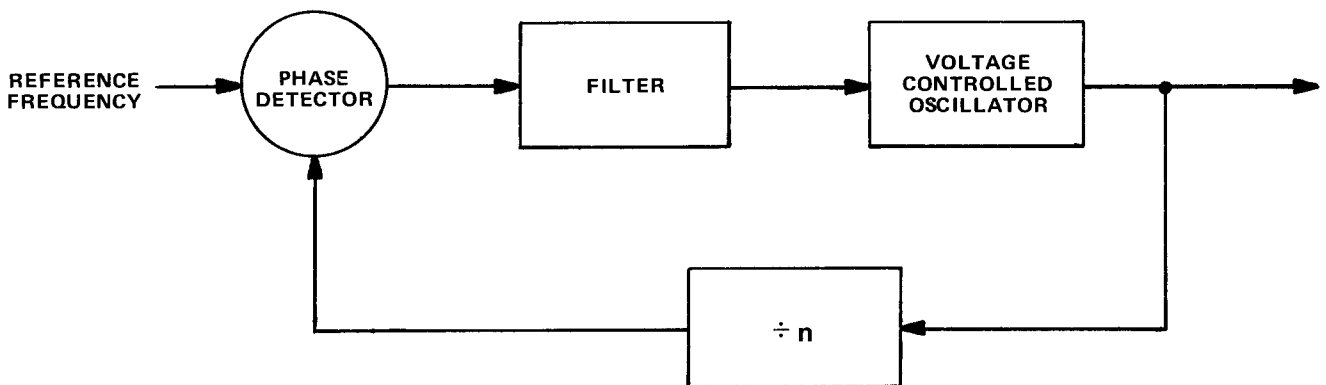

Fig. 2-3. Voltage Controlled Oscillator in Phase Locked Loop.

Theory of Operation—7D11 Service

from the 500-megahertz VCO. Any phase difference between the two signals is detected and presented to error amplifier U240. U240 presents a correction voltage to varicap CR252, in parallel with the tank circuit of the 500-megahertz voltage controlled oscillator.

R247, R248, R249, and CR248 form a correction network to compensate for the non-linear characteristics of the varicap. The 500-megahertz voltage-controlled oscillator is a modified Colpitts configuration. The tank circuit is formed by L253, integrated into the etched circuit board, plus CR252, C253, C258, C259, and C260.

The output of the 500-megahertz oscillator is directed through buffer stage Q261 to the Countdown Buffer, Q383, and to the Phase Lock Buffer, Q265. The output of Q265, 500 megahertz, is applied to a synchronous 100-megahertz Multi, CR271 and L271, where it is divided by five. The resultant 100-megahertz signal then enters the Phase Lock Ring Counter through the Phase Lock Ring Counter Driver formed by Q274 and Q277.

Phase Lock Ring Counter Driver. Q274 and Q277 are connected as an emitter-coupled current switch. The output of the Phase Lock Divide-by-Five Tunnel Diode Multi is connected to the base of Q274. The output is taken from the collector of Q277. When the tunnel diode output is HI, Q277 conducts and Q274 is turned off. The output at the collector of Q277 is, therefore, in phase with the output of the tunnel diode.

The Phase Lock Ring Counter, Q285 through Q312, also divides the 100-megahertz signal by five. The operation of the Phase Lock Ring Counter, except for the reset function, is identical to the one formed by Q401 through Q424, which is described later. The signal, which is now 20 megahertz, is routed from the ring counter through the level shifter (Q316, Q319, and Q324), to a $\div 20$ counter made up of U327 and U329. The 20-megahertz signal is divided by two through U327 and divided by 10 through U329 to provide a one-megahertz signal, which represents the 500-megahertz VCO divided by 50. This one-megahertz signal is then presented to Phase Detector U230, where it is compared to the one-megahertz (reference frequency) signal from U205. This feedback method provides the means by which the 500-megahertz oscillator is kept exactly on frequency.

Fine Delay

To compensate for internal propagation delays of the 7D11, the delay time is calibrated to provide the delay time indicated by the readout from the EXT TRIG IN connector to the DLY'D TRIG OUT connector when R336 is set for zero. The fine delay circuit provides an additional 100 nanoseconds delay, adjustable by R336.

The fine delay stage is a variable pulse width multi. The delay time is triggered by a pulse from the trigger circuit, which allows Q364 to conduct for the length of the delay interval. The trigger pulse formed by the shaping network; C353, R353, R354, and CR354, interrupts the conduction of Q356, which raises the base voltage of Q364 to a higher level than that present at the base of Q347. The positive transition at the emitter of Q364 is fed back through C358 to the emitter of Q356. The amplitude of this transition is dependent upon the relative voltage levels at the bases of Q347 and Q364. The level at the base of Q347 is determined by the setting of the FINE DELAY control, R336. C358 discharges through current source Q358 causing the voltage at the emitter of Q356 to drop. Q356 starts conducting as its emitter approaches zero volts, which then causes Q364 to stop conducting to end the delay interval.

When Q364 conducts, its collector voltage drops (negative-going pulse edge—fine delay interval start) then returns to its normal level (positive-going pulse edge—end of delay interval) as determined by the setting of R336. The positive-going edge of the pulse is shaped by CR364, R365, and C366, and routed to CR370 in the Time Count Switch.

Gated Countdown

The stage, composed of CR370, Q371, and Q375 in conjunction with CR386, L378, R377, and R378, form a gated 100-megahertz oscillator. As CR370 triggers to its high state, it trips the Schmitt trigger formed by Q371 and Q375, allowing CR386 to be biased in its astable region and operated as a 100-megahertz multivibrator. Within two nanoseconds, CR386 "Locks" onto the first available 500-megahertz cycle, effectively dividing the 500-megahertz signal by five. Because the trigger can occur at any time, a one-count (two nanosecond) uncertainty is present in the time required to start dividing down the 500-megahertz reference.

Gated Ring Counter Driver. Q388 and Q391 are connected as an emitter-coupled amplifier to provide isolation and level shifting for driving the ring counter. When the tunnel diode output is HI, Q391 conducts and Q388 is turned off. Therefore, the output at the collector of Q391 is in phase with the output of the tunnel diode.

Gated Ring Counter. The Gated Ring Counter is made up of five DC coupled multivibrators. Each multivibrator (multi) receives the input signal, however, the ring counter configuration is such that an input will change the state of only one multi. In turn, this conditions the succeeding multi to respond to the next input, etc. A simplified diagram of the ring counter is shown in Fig. 2-4. Each multi is made up of two transistors. The multis are identified in Fig. 2-4(A) as multi A, Q401 and Q404; multi B, Q406 and

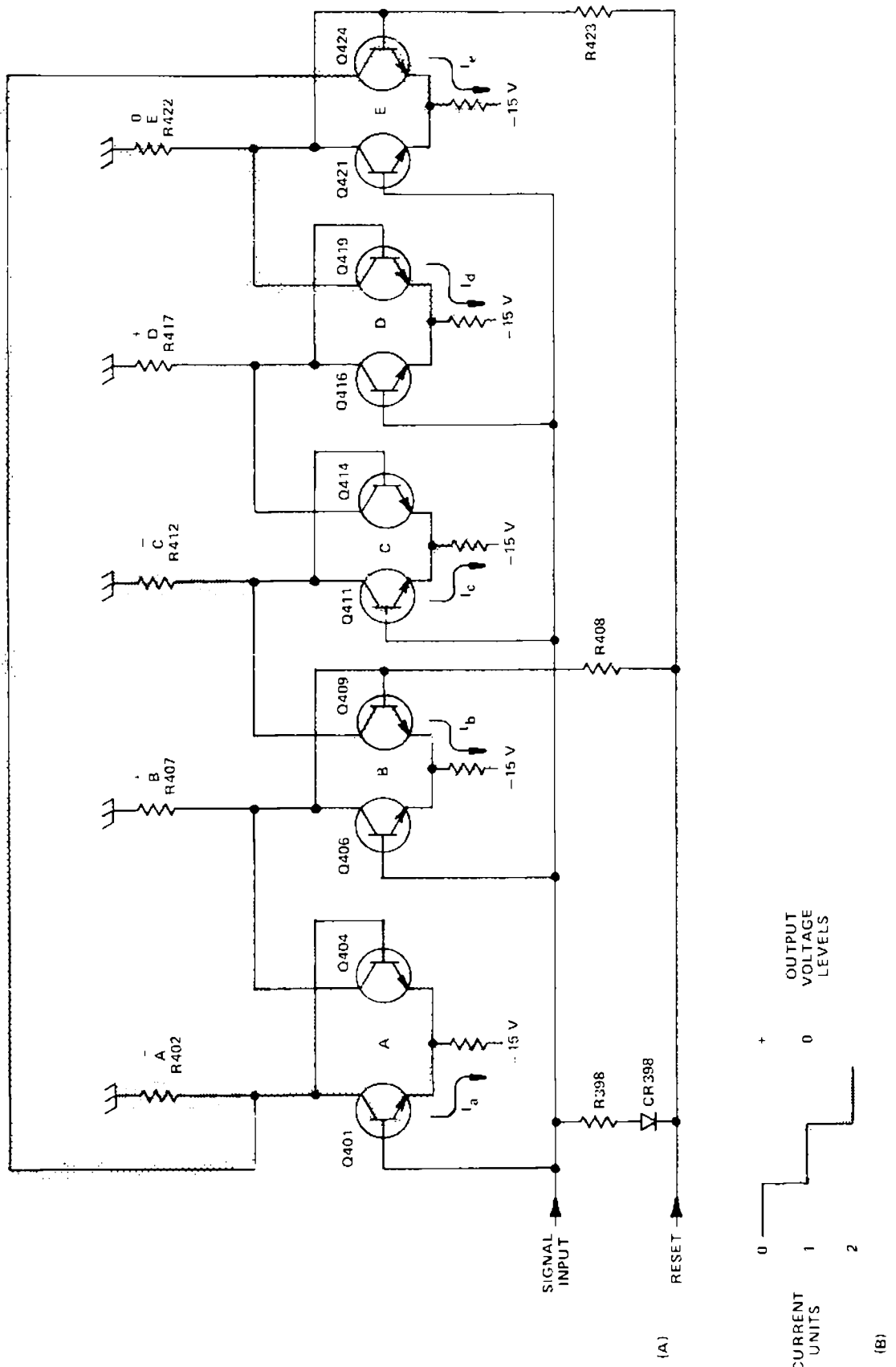

Fig. 2-4. (A) Ring Counter simplified schematic diagram; (B) Multivibrator current units/output voltage levels chart.

Theory of Operation—7D11 Service

Q409; multi C, Q411 and Q414; multi D, Q416 and Q419; and multi E, Q421 and Q424. The output load resistor is shown above the left transistor of each multi. The left transistor in each multi receives the input signal.

In each multi, the emitter-resistor current (e.g., I_a) will flow through the transistor which has the more positive base level. The current through a multi load resistor is determined by the state of the corresponding multi and the preceding one. Therefore, the load resistor current can be at one of three levels; and, this will result in one of three voltage levels dropped across the load resistor. For example, the voltage dropped across the load resistor B may be due to one current unit (I_a or I_b), two current units ($I_a + I_b$), or zero. The voltage levels resulting from zero, one, and two current units through a load resistor are represented in Fig. 2-4(B); and are labeled +, 0, and - respectively.

The ring reset input resets the ring counter to the state that will output to the next divider stage (U44A) on the first available count to minimize propagation delay. A momentary HI reset level is applied to the base of the left transistor in each multi through CR398 and R398, and to the right transistor in multis B and E through R408 and R423 respectively. This causes the left transistor in multis A, C, and D to have the more positive base and the right transistor in multis B and E to have the more positive base. As a result, emitter-resistor current flows through the right transistor in multis B and E and through the left transistor in multis A, C, and D.

After reset, the state of each multi is shown in Fig. 2-4(A) by the direction of the arrow representing emitter-resistor current. The resultant voltage dropped across each load resistor is A, -; B, +; C, -; D, +; and E, 0. The multi output voltage is applied to the base of the right transistor through a zener diode. The zener diode provides level shifting to keep the relative voltage level between the right and left transistor bases the same. As reset is applied, the counter assumes the state shown in Fig. 2-5 labeled RESET HI and changes to the state labeled RESET LO as the reset pulse is removed.

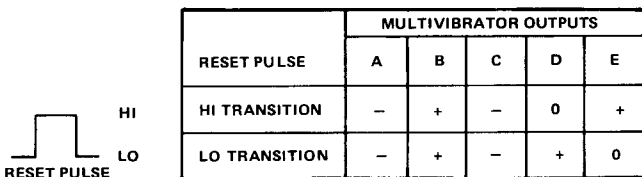

Fig. 2-5. Ring counter reset function.

Fig. 2-6 shows the ring counter output in relation to the signal input to the counter. At the first signal input, the ring counter input goes HI. This pulls the base of each left

transistor HI towards a forward-bias condition. Since the left transistors in multis A and C are already conducting, the HI input has no effect. Due to the voltage across the load resistors (+ level), the bases of the right transistors of multis B and D are sufficiently positive that the right transistors continue to conduct. The voltage on the base of the right transistor in multi E is at the 0 level, and the HI signal input causes multi E to change state.

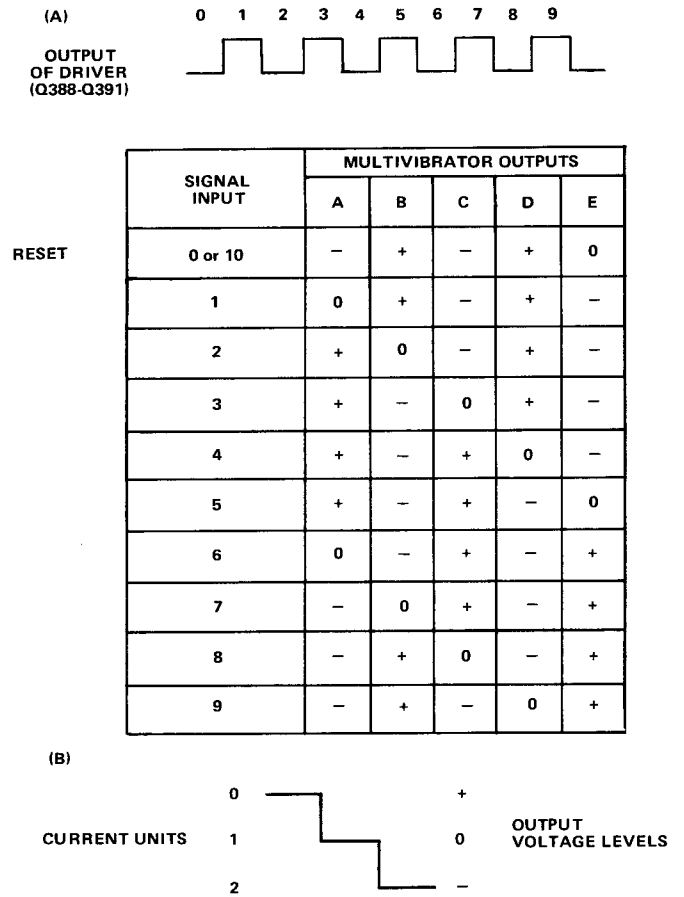

Fig. 2-6. (A) Ring Counter Driver signal output; (B) Ring Counter output levels.

The change of state of multi E changes the voltage across load resistors A and E. The output voltage levels are now: A, 0; B, +; C, -; D, +; E, -. As the first signal input ends, the signal input goes LO. This tends to reverse bias the left transistor in each multi, but causes only multi A to change state. The right transistors of multis B and D are already forward biased, and the left transistors of multis C and E are sufficiently forward biased to remain conducting.

This sequence of operation continues for the remainder of the signal input. The output voltage levels after each signal input are shown in Fig. 2-6(B). The multi which has the 0 level output changes state in each input transition.

Ring Counter Output. The ring counter output comparator provides the 20-megahertz signal (100 megahertz

divided by 5) to the next divider stage, U444A. The output is a HI to LO level transition at the emitter of Q440. Emitter-coupled pair Q431 and Q433 compares the voltage levels at the bases of Q404 and Q409 to compare the output levels of multivibrators A and B. The multi with the more positive base controls the conduction of Q431 or Q433. When the Ring Counter is reset, the output level of multi A is lower than that of multi B [see line "0" of Fig. 2-6(B)]. The first complete input cycle causes this state to reverse [transition from line 1 to line 2 of Fig. 2-6(B)], which reverses the condition of Q431 and Q433 and causes a negative transition at the emitter of Q440.

U444A divides the 20-megahertz signal by two and presents the resultant 10-megahertz signal to S444. The 10-megahertz output of U444A is also applied to the clock input of U444B. U444B divides the 10-megahertz signal by two, to provide a five-megahertz signal for operation in the ECHO mode. Either signal, NORMAL (10-megahertz) or ECHO (five-megahertz), is selected at S444 and presented to the base of Q502, the Time Count Source Gate.

OUTPUTS PROCESSING AND EVENTS START TRIGGER 3

The Outputs Processing and Events Start Trigger diagram contains the various reset and output circuits of the 7D11. It also contains the Events Start Trigger circuit.

Time/Events Count Source Gate

The Time/Events Count Source Gate comprises Q502, Q504, Q508, Q512, Q514, and Q518. When the Count Mode Switch is in the TIME INT CLOCK or the EXT 1 MHz position, the 10-megahertz signal from the Phase Lock Loop and Gated Countdown circuits applied to the base of Q502, is allowed to pass through Q508 to the Delaying Counter and to the base of Q525. When the Count Mode Switch is in the EVENTS position, the events signal from U640D on the trigger circuit is routed through Q512 and Q518 to the Delaying Counter and to the base of Q525.

Q525 is armed by the Delaying Counter at one count less than overflow. The following pulse, which is accepted as the end of count, is now synchronously gated through the Output Release Gate, Q525. The output of Q525 is a pulse applied to the clock inputs of U543A and U543B causing them to change state (Q goes to its HI state). U543A is the Delayed Trigger Output Flip-Flop and U543B is the Delay Gate Flip-Flop.

Delayed Trigger Output Flip-Flop

The change of state of U543A causes several functions to happen. The negative transition at pin 6 of U543A causes a multivibrator, composed of Q562 and Q565 to output the DLY'D TRIG OUT signal through the 50-ohm matching amplifier, Q568. This delayed trigger pulse is timed to stay in the HI state for approximately 200-250 nanoseconds (see Fig. 2-7). This same output signal from

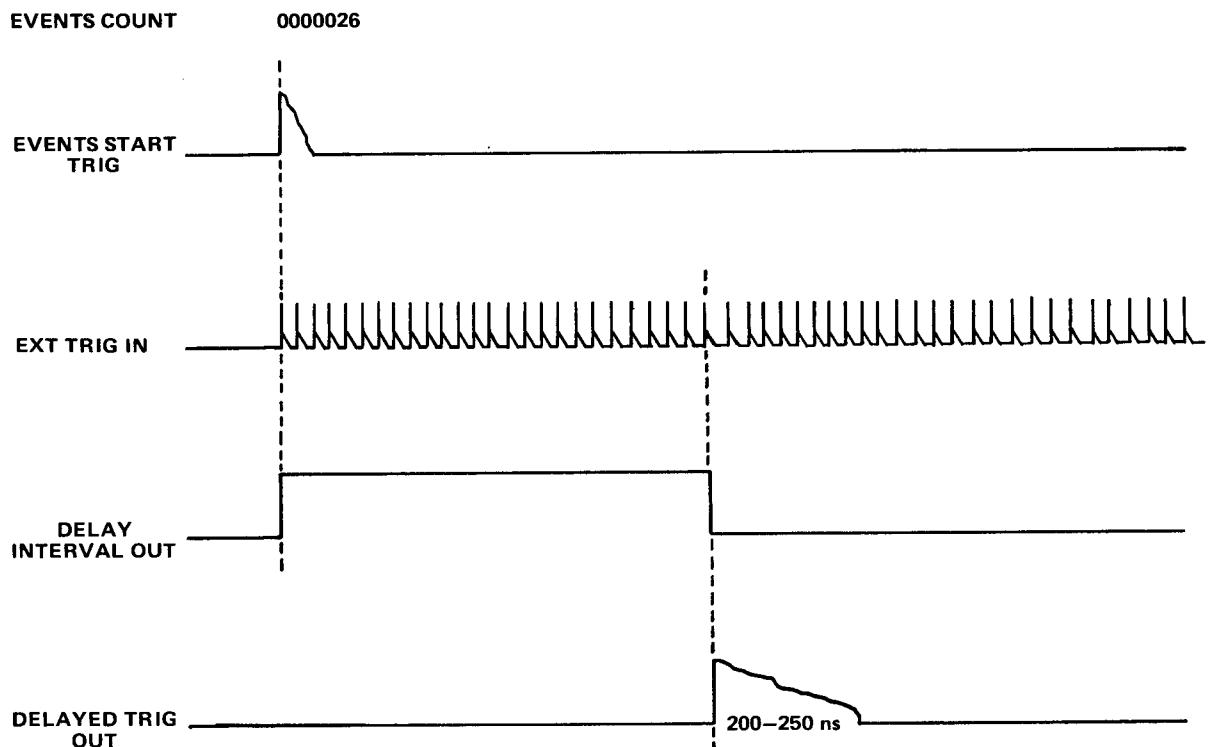

Fig. 2-7. 7D11 Outputs Timing diagram.

Theory of Operation—7D11 Service

U543A is coupled through T579 to provide a fast push-pull trigger signal out the interface connector on pin A13 (+) and on pin B13 (-). This is compatible with plug-in time base units that accept the vertical trigger signal from the vertical compartment.

Coincident with the delayed trigger out, the delay interval out is returned to a LO state (see Fig. 2-7). This happens when U543A changes state, causing Q648 and Q653 to stop conducting. Q648 and Q653 conduct during the delay interval to indicate a delay is in process. A delay interval indication is also provided on the interface connector pin A17. During the delay interval, Q662 conducts to provide optional Z-axis intensification selected by the position of S669. This same signal, present on interface connector pin A11, provides vertical deflection of the display when the 7D11 is used in a vertical plug-in compartment of the associated mainframe.

When U543A changes state at the end of the delay interval, its output at pin 5 is routed through U586B and U586A. The output of U586A causes multivibrators U589A, U589B, and U598A to change state (see Fig. 2-8) and begin their prescribed timing periods. The timing of each multivibrator is determined by its respective external resistor and capacitor components.

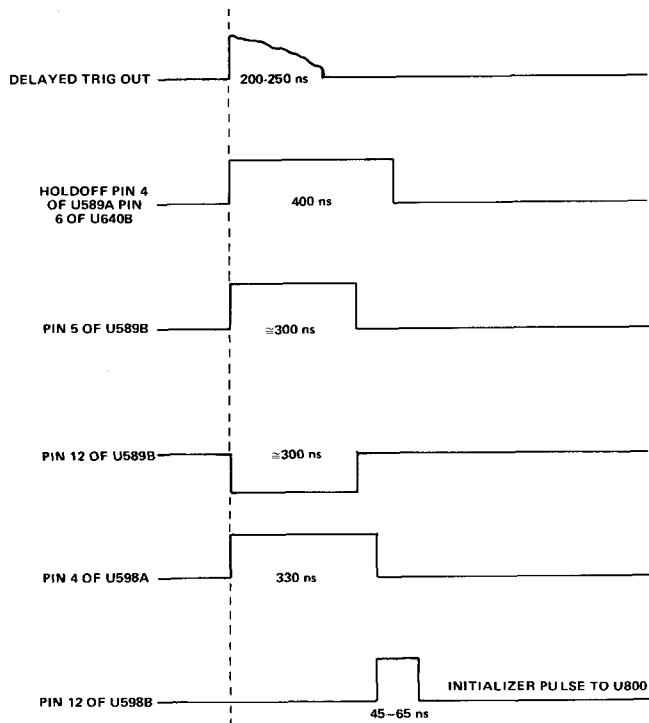

Fig. 2-8. 7D11 Reset function Timing diagram.

When U589A changes state (for 400 nanoseconds), the LO output at pin 4 activates trigger holdoff through U640A

and U640B to prevent another trigger pulse from being accepted while the 7D11 circuits are being reset. The HI output on pin 13 is coupled back through U586D to clear U543A.

During the timing interval of U589B, approximately 250 nanoseconds, (see Fig. 2-8) the gated countdown ring counter is reset through Q682, Q684, and Q687. Simultaneously, the LO output at pin 12 resets U444, CR370 (through CR369), and provides the reload command to the Delaying Counter (U800-U812).

As U598A (timed for 330 nanoseconds) returns to its normal state, the positive transition on pin 4 causes U598B to change state briefly (45 to 65 nanoseconds). The output at pin 12 of U598B becomes the initializing pulse through either Q508 or Q518 to pin 8 of U800.

When the RESET button is pressed, Q595 conducts to provide a positive-going pulse, which is coupled into pin 6 of U586B. This performs the same reset functions as described above for the change of state of U543A.

Delayed Gate Flip-Flop

During the delay interval, pin 9 of U543B is LO, so Q546 is not conducting and the sweep is locked out by a HI current level on interface connector pin B9. At the end of the delay interval U543B changes state and causes Q546 to saturate to divert the current from Q547 to ground. This allows the B time base to start the sweep or, if in the armed mode, allows the B time base to start the sweep after receipt of a trigger. In the INDEPENDENT mode Q546 is saturated by a voltage applied through R545 to allow the B sweep to operate independently of the 7D11.

At the end of the sweep, the time base unit presents a HI pulse to interface connector pin B8, Sweep Lockout connector. This pulse is coupled through Q532 as a positive voltage on the base of Q538. This positive voltage allows Q538 to conduct, causing a negative-going pulse at its collector, which, in turn, clears U543B. This stops the conduction of Q546, which, again, causes sweep lockout.

The B SWEEP DELAY MODE switch, S555, provides one of three voltage levels out on interface connector pin B2. In the INDEPENDENT mode a ground level is present to allow the B time-base unit to operate independently of the 7D11. In the B STARTS AFTER DELAY mode, 5 volts is present, which allows the B time-base unit to start the sweep at the end of the delay interval. The B TRIGGERABLE AFTER DELAY mode places a voltage level of 3.8 volts on interface connector pin B2. This arms the tunnel diode circuit in the B time base unit to start the sweep after

receipt of a trigger. C535 and R535 couple a positive-going transient to the base of Q538 whenever S555 is switched from INDEPENDENT to one of the two slaved modes. This ensures that the B time base is locked out initially by forcing U543B to clear.

Events Start Trigger

The Events Start Trigger circuit is used to end holdoff in the delay by events mode. The input impedance is approximately 1 megohm, determined by R601 and R609. CR605 and CR609 prevent overdriving the input by clamping the input signal should it be excessive. The circuit is a very high gain amplifier composed of Q620, Q624, Q628, and Q630. It has a dual FET input connected for a zero temperature coefficient with no offset between the gate and source of Q610A. The trigger LEVEL is adjustable by R615. It varies the DC voltage at the base of Q620 and compares it with that at the base of Q624.

The SLOPE (+ or -), selected by S615, determines which collector is chosen for the output. In the + position, Q634 is turned off and the collector of Q628 is pulled high through CR632, which reverse biases CR635. This causes the output of Q630 to be routed through CR636 to the base of Q637. In the - position Q634 is turned on, pulling the collector of Q630 high, reverse biasing CR636. The output at the collector of Q628 is presented to the base of Q637 through CR635. Q637 provides isolation for the trigger circuit output.

U640C and Q640 form a one-shot multivibrator. The input is normally HI so the active input signal is a negative-going transition. CR638 is a feed-through diode in parallel with a delay circuit comprising U640C, R638, C639, CR639, and R639. The signal at the base of Q640 is a negative-going pulse, the width of which is determined by the delay through U640C, etc.

The output at pin 6 of the holdoff RS flip-flop formed by U640B and U640A is reset to a HI logic level after each reset cycle. The negative-going pulse at the collector of Q640 causes the holdoff flip-flop to change state so that a LO logic level is presented at pin 6 of U640B. This ends holdoff to allow the 7D11 trigger circuit to become active.

Q641 conducts in the delay by time mode. This holds pin 1 of U640A LO to allow holdoff to follow the timing of U589A (see Fig. 2-8).

DELAYING COUNTER AND DISPLAY GENERATOR

The Delaying Counter and Display Generator consists of the Voltage to Frequency Converter, Up/Down Count

Control, Up/Down Clock Steering, Power-On Initializer, Reversible Counter, Counter Buffers, Delaying Counter, Nines Detector, and the Nines Arm Gate.

Voltage To Frequency Converter

The Voltage to Frequency Converter provides the signal used for incrementing the Reversible Counter, which permits presetting the desired delay time or events count. The DELAY TIME or EVENTS knob, R700, is spring loaded to its mechanical and electrical center. Turning it counterclockwise causes the delay count to be decreased; turning it clockwise causes the delay count to be increased. Rotating R700 applies either a positive or negative voltage on its wiper. This condition is sensed by Q718 or Q721 through diodes CR712 or CR713 respectively, and, through a separate path, by Q705. As Q718 and Q712 are turned on they cause Q724 to conduct. Q724 is a current generator that charges C725. The waveform at C725 is a voltage sawtooth. The waveform is applied to source follower Q733 and through a zener diode network to emitter follower Q740. Emitter follower Q740 drives a common base stage, Q743, to output this sawtooth waveform to the inputs of the steering network, U747A and U747B, of the Reversible Counter. It is also applied to inverter U749F to update the number that is loaded into the Delaying Counter. Also, the sawtooth is applied to the base of Q738. At the peak of the sawtooth wave, the emitter of Q738 drives Q730 to conduct, discharging C725. The waveform on C725 having fallen, the feedback path through Q733, Q740, Q743, Q738, and Q730 collapses and C725 is permitted to start charging again. The repetition rate is determined by the collector current of Q718 and Q721 as determined by the magnitude of the rotation of the DELAY TIME OR EVENTS control, R700. Increasing the rotation of R700, either clockwise or counterclockwise, is converted into more charging current in C725, thereby increasing the repetition frequency. This stage operates as a voltage to frequency converter. In idle condition, Q730 is turned on by current through CR729 to keep C725 from charging. When setting the counter (rotating R700), Q721 turns on Q727 to reverse bias CR729, which prevents Q730 from being turned on except through the feedback path.

The output of Q743, through U749F, resets (force recycle) the circuits in the Outputs Processing and Events Start Trigger (diagram 3). This, in turn, provides the reload signal for U800-U812 to ensure that the Delaying Counter is updated along with the Reversible Counter.

Up/Down Count Control and Steering. The output of Q743 is applied to the inputs of U747 to cause the Reversible Counter to count either up or down. The steering is derived from the voltage (positive or negative) present when the DELAY TIME OR EVENTS knob, R700, is turned. This voltage operates the Schmitt output circuit formed by Q705 and Q707 to cause the count signal to be gated through either U747A for counting up or through U747B for counting down.

Reversible Counter and Nines Complement Review

The nines complement of a number can be defined as the value that must be added to the number to yield nine. For example, the nines complement of 7 is 2 because 2 must be added to 7 to obtain 9. When a count is loaded into the Reversible Counter, it is set up as the nines complement in binary coded decimal form. To illustrate, the Reversible Counter BCD inputs are preloaded to the minimum delay count (0000001) when the RESET button is pressed. The BCD inputs (pins 15, 1, 10, and 9) to U760 are preset to encode, upon receipt of a load command at pin 11, the number eight, which is the nines complement of number one. The BCD inputs to U762 through U772 are preloaded to encode the number nine, the complement of which is zero. The readout encoding circuits invert this BCD information (the 9999998 in the Reversible Counter) so the number displayed on the CRT after power-on initialization or RESET is the minimum delay or events count of 0000001. All values of delay or event counts, as well, are entered into the Reversible Counter by the DELAY TIME OR EVENTS knob as previously described.

When the DELAY TIME OR EVENTS knob, R700, is turned, the output of U747 allows what will be interpreted as the nines complement of the desired delay time or events count to be set up in the Reversible Counter, U760-U772. The BCD inputs to the counter are preset to load the nines complement of the minimum count (0000001) when the RESET button is pressed. U760 resets to BCD eight and U762-U772 are reset to BCD nines. The BCD outputs of the Reversible Counter are routed through the Counter Buffers, U780-U792, to the Readout Encoding circuits and to the Delaying Counter.

Delaying Counter

The Delaying Counter, U800-U812, is used for arming Q525 in the Outputs Processing circuit by turning off Q838 (see Fig. 2-9). The network between the outputs of the Delaying Counter and the base of Q835, composed of U820, U749B, U825, U749E, CR830, and CR832, form a 14-input, positive AND gate. The output of this Nines Detector will go HI only when these 14 inputs are HI. This occurs when the Q_A and Q_D outputs of the Delaying Counter are at a HI logic level (BCD nines), enabling the Nines Detector circuit to turn on Q835. Q835 and Q838 comprise the Nines Arm Gate. Q838 is turned off when Q835 conducts.

The nines complement of the delay time or events count from the Counter Buffer is applied to the BCD inputs to the Delaying Counter. During each reset cycle, a reload signal, applied to pin 1 of each of the Delaying Counter IC's, allows these inputs to be loaded into the Delaying Counter, the Delaying Counter is advanced toward overflow by the delay time or events count signal applied to pin 8 of U800. When the minimum count is loaded into the

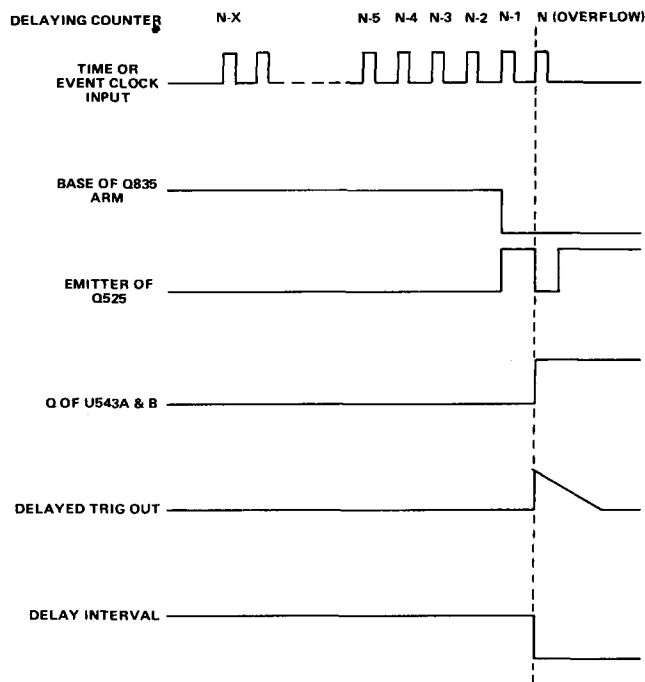

Fig. 2-9. Delaying Counter and Outputs Timing diagram.

Reversible and Delaying Counters, as occurs when the RESET button is pressed, it is the complement (9999998) of the displayed 0000001 that is loaded. Keeping in mind that Q525 is armed when the Delaying Counter is at 9999999 and that Q525 conducts when the Delaying Counter overflows, it is apparent that even though the display indicates a delay count of one, two counts are required for Q525 to effect an output. Therefore, an initializing pulse is applied to pin 8 of U800 at the end of each reset cycle to provide a plus one advancing count to the Delaying Counter. It must be remembered that the Nines Detector arms Q525 when all the Delaying Counter outputs are binary coded nines. The actual output of the 7D11 will occur on the next following delay time or events count pulse.

Power-On Initializer

The Power-On Initializer, composed of Q753 and Q755, provides a negative-going pulse to load the Reversible Counter for minimum delay and also for initially resetting the Output Processing circuits. This is accomplished when power is applied by the charging time constant of R751 and C751. C751 charges to approximately one volt, causing Q753 to conduct. The conduction of Q753, applied to the gate of SCR, Q755, causes it to strike down. This negative transition at the collector of Q753 is coupled through C755 to apply a reload pulse to pin 11 of the Reversible Counter IC's, U760-U772. The SCR remains in its low conduction mode until power on the instrument is recycled.

Reset

The front panel RESET button will effect a reload of the Reversible Counter to display the minimum count in a fashion similar to the POWER-ON Initializer. A negative-going transition, the grounding of the junction of R756 and R757, is generated when the button is pressed, and is also applied to the Reversible Counter and to the Outputs Processing circuits.

READOUT ENCODING

The Readout Encoding circuits provide the necessary data to encode the Readout System (located in the mainframe) to display the 7D11 readout. The Readout Encoding diagram contains the Time-Slot Converters, BCD Multiplexers, Readout Encoder, Leading 1 Inserter, Zero Cancel, and Legend circuits.

The outputs of U902, U906, U910, U914, U918, U922, and U926 are the complement, or inverse, of their respective inputs from the Delaying Counter and Display Generator (diagram 4). The outputs of U902-U926 are enabled, one at a time, as their respective time-slot pulses cut off the FET's connected to their inputs. For example, when time-slot 2 is active, it stops the conduction of Q924, which allows its associated inputs to U926 to go to a HI logic level. This, in turn, causes U926 to output the complement of the information input from U792. The outputs of U926 are routed through diodes CR930, CR932, CR934, and CR936 where they derive current levels through resistors R960, R961, R962, and R963. These currents, through diodes CR960, CR961, CR962, and CR963, add together to form a current level through Q968, R965, and CR965. This current level is routed to the base of U974E, which provides the output to the interface connector to allow the appropriate number to be displayed on the CRT. Subsequent numbers are displayed during their respective time-slots in the same manner.

Leading 1 Insertion. In order that an eighth digit may be displayed when inputs to U902-U926 are coded to display 9's (the outputs of U902-U926 are inverted, therefore, the actual displays are the complements, or zeros), these inputs are all routed to U749D and U948. When all these inputs are at a HI logic level and time-slot 1 is active, U948 will go LO and, through CR953, will allow a 1 to be displayed. This is equal to 1 second in the time mode or a maximum count of 10,000,000 events. If no 1 is to be displayed, time-slot 1 is skipped.

Zero Blanking. When no leading 1 is to be displayed, the inputs to U747C are at a HI logic level which allows its LO logic level output to provide a current path through CR955 and CR954. This permits a current corresponding to a "skip" command to flow through Q968. Since the current

through Q968 is "mirrored" through U974E, the mainframe readout system skips time-slot 1 and nothing is displayed.

If there was no number 1 to be displayed during time-slot 1, a zero appearing in time-slot 2 will be blanked. If a zero is blanked in time-slot 2, then a zero appearing in time-slot 3 will also be blanked. This is accomplished in the following manner: During time-slot 2, U926 is enabled by Q924, and, if it is coded to display a zero, pins 1 and 10 will be LO. Therefore, the output of U940C is HI, which causes the output of U940D to be LO. This, in turn, causes the output of U940A to be HI. Since time-slot 1 was blanked, the output of U948 is HI. Each time time-slot 4 is present, the input to U952C goes LO and causes its output to go HI. Therefore, all inputs to U952A are HI and its output is LO. In this case it keeps the output of U952C HI, which allows Q970 to conduct and turn on U974D. The conduction of U974D, through CR973, drains the current from the base of U974E to blank time-slot 2.

If a zero appears during time-slot 3, it is blanked in the same manner that the zero in time-slot 2 was blanked except that U974D conducts through CR972.

If some number other than zero is to be displayed in time-slot 2 or 3, one of the inputs to U940C will be at a HI logic level as will one of the inputs to U940B, depending on which time-slot (2 or 3) is active. This causes the output of U940D to go to a HI logic level, which causes a LO output from U940A to be applied to an input to U952A. The output of U952A then goes HI, and, since the output of U952B is also HI, the output of U952C goes LO to stop the conduction of Q970. When Q970 stops conduction, it prevents U974D from conducting so that no blanking can occur.

Legend. In the DELAY BY TIME mode, current (row and column) is generated through U974A and U974C during time-slot 9 to display a + in the readout. This is provided as a reminder to add the FINE DELAY time to that indicated by the readout. During time-slot 10, row current is generated through U984C and U984D to display a decimal point in the readout. U984B and U984E generate row and column current during time-slots 4 and 5 to display ms in channel 2 (the lower display position).

In the delay by EVENTS mode, a signal from Q518 prevents the display of these characters and also prevents zero blanking.

POWER DISTRIBUTION AND MAINFRAME CONNECTOR

Diagram 6 shows the mainframe connector and the power distribution for the 7D11. Decoupled +15 volts, -15

Theory of Operation—7D11 Service

volts, +5 volts, and -5 volts are routed to the various circuits. In addition to these voltages, a regulated, decoupled +4.9 volts is provided by the DC inverter described below.

DC Inverter

This is a +15 volt to +4.9 volt inverter of the switching regulator type. Q1025 and Q1028 form a differential comparator that compares a reference voltage of approximately 4.9 volts against the unfiltered output of the regulator at C1038.

R1034 introduces a small amount of positive feedback and hysteresis into the circuit by causing the 4.9 volt reference at the base of Q1028 to vary slightly. If the regulator output voltage is low (below 4.9 volts), Q1025 is turned off and Q1028 conducts. This turns on Q1036 and Q1038, causing them to saturate. Current flows through these two transistors through T1038, which stores energy in the form of a magnetic field. The current through T1038 flows out of the regulator and into the load and causes the output voltage to rise.

When Q1038 turns on, its collector voltage approaches 15 volts causing the 4.9 volt reference at the base of Q1028 to rise several hundred millivolts because of R1034.

When the output voltage of the regulator rises sufficiently to equal this new reference voltage, Q1028 turns off and Q1025 turns on. This causes Q1036 and Q1038 to stop conduction.

Because of the inductance of T1038, the current flow through it tries to remain constant. This causes the collector of Q1038 and the base of Q1034 to seek a voltage, negative enough with respect to the converter output, to maintain this current flow. When the voltage at the base of Q1034 drops to approximately -0.7 volts, the base-collector junction of Q1034 forward biases and Q1034 operates in an inverted mode (emitter and collector reversed). When Q1034 saturates (in the inverted mode) the voltage at the tap of T1038 is maintained at a voltage of approximately -0.1 to -0.2 volts. The majority of the current flow through T1038 is now absorbed through Q1034.

The current through T1038 starts to decay through the load and C1038. When Q1038 turned off, the voltage at its collector dropped to approximately -0.7 volts. This causes the 4.9 volt reference to drop by several hundred millivolts because of R1034.

When the output voltage of the regulator falls to a value approaching this new reference voltage, Q1028 turns on and Q1025 turns off and the cycle repeats.

The duty cycle during which Q1038 supplies current is approximately the ratio of the output voltage to the input voltage (4.9/15).

L1020 and C1020 provide filtering so that the +15 volt supply sees a more constant current load instead of the low duty cycle, relatively high current waveform of Q1038. L1039 and C1039 provide filtering for the ripple which is inherent in this form of regulator. Fuse, F1020, protects the regulator from short circuit and overloading.

By providing a tap on T1038, Q1038 and Q1036 can reach saturation simultaneously during the conduction cycle. By operating Q1034 in the inverted mode, it appears as a very low voltage drop diode between the emitter and collector terminals during the non-operative portion of the cycle. The result is a very high overall operating efficiency of approximately ninety percent.

INTRODUCTION TO THE READOUT SYSTEM

Introduction

The following discussion is provided to acquaint the 7D11 user with the Readout System employed in Tektronix 7000-series Oscilloscopes. Since the oscilloscope Readout System provides the readout for the 7D11, it is necessary to relate the function of the 7D11 to the Readout System to gain a better understanding of the 7D11 operation. A detailed circuit description of the 7000-series Readout system is given in the oscilloscope instruction manual.

The Readout System

The Readout System in the 7000-series oscilloscopes provides alpha-numeric display of information encoded by the plug-in units. This display is presented on the CRT and is written by the CRT beam on a time-shared basis with the analog waveform display.

The Readout System produces a pulse train consisting of ten negative-going pulses called time-slots. These pulses represent a possible character in a readout word, and each is assigned a time-slot number corresponding to its position in the word. Each time-slot pulse is directed to one of ten output lines, labeled TS-1 through TS-10 (time-slots one through ten), which are connected to the vertical and horizontal plug-in compartments. Two output lines, row and column, are connected from each channel (two channels per plug-in compartment) back to the Readout System.

Data is encoded on these output lines either by connecting resistors between them and the time-slot input lines or by generating equivalent currents. The resultant output is a sequence of analog current levels on the row and

column output lines. The row and column current levels are decoded by the Readout System to address a character matrix during each time-slot, thus selecting a character to be displayed or a special instruction to be followed.

MAINTENANCE

INTRODUCTION

This section of the manual contains maintenance information for use in preventive maintenance, corrective maintenance, and troubleshooting of the 7D11.

Further maintenance information relating to component color codes and soldering techniques can be found in the instruction manuals for the 7000-series oscilloscopes.

PREVENTIVE MAINTENANCE

General

Preventive maintenance, consisting of cleaning, visual inspection, lubrication, etc., performed on a regular basis, will improve the reliability of this instrument. Periodic checks on the semiconductor devices used in the unit are not recommended as a preventive maintenance measure. See semiconductor-checking information given under troubleshooting.

Cleaning



Avoid the use of chemical cleaning agents which might damage the plastics in this instrument. Avoid chemicals containing benzene, toluene, xylene, acetone, or similar solvents.

Front Panel. Loose dust may be removed with a soft cloth or a dry brush. Water and mild detergent may be used; however, abrasive cleaners should not be used.

Interior. Cleaning the interior of the unit should precede calibration, since the cleaning process could alter the settings of the calibration adjustments. Use low-velocity compressed air to blow off the accumulated dust. Hardened dirt can be removed with a soft, dry brush, cotton-tipped swab, or cloth dampened with a mild detergent and water solution.

Lubrication

Use a cleaning-type lubricant on shaft bushings, interconnecting plug contacts, and switch contacts. Lubricate switch detents with a heavier grease. A lubrication kit containing the necessary lubricating materials and instructions is available through any Tektronix Field Office. Order Tektronix Part No. 003-0342-01.

Recalibration

To ensure accurate measurements, the 7D11 should be checked after each 1000 hours of operation or every six months if used infrequently. A complete performance check procedure is given in Section 4.

The performance check procedure can be helpful in isolating major troubles in the unit. Moreover, minor troubles not apparent during regular operation may be revealed and corrected.

TROUBLESHOOTING

General

The following is provided to augment information contained in other sections of this manual for use in troubleshooting the 7D11. The schematic diagrams, Circuit Description, and Calibration sections should be used to full advantage. The Circuit Description section gives detailed information on circuit behavior and output requirements.

Troubleshooting Aids

Diagrams. Circuit diagrams are given on foldout pages in Section 6. The circuit number and electrical value of each component in this instrument are shown on the diagrams. Important voltages are also shown.

Circuit Boards. The circuit boards used in the 7D11 are outlined on the schematic diagrams, and an illustration of each board is shown on the back of the circuit diagram foldout pages. Each board-mounted electrical component is identified on the illustration by its circuit number.

Component and Wiring Color Code. Colored stripes or dots on resistors and capacitors signify electrical values, tolerances, etc., according to the EIA standard color code. Components not color coded usually have the value printed on the body.

Maintenance—7D11 Service

The insulated wires used for interconnection in the 7D11 are color coded to facilitate tracing a wire from one point to another in the unit.

Semiconductor Lead Configuration. Fig. 6-1 shows the lead configuration of the semiconductor devices used in this instrument.

Troubleshooting Equipment

The following equipment is useful for troubleshooting the 7D11:

1. **Semiconductor Tester**—Some means of testing the transistors, diodes, and FET's used in this instrument is helpful. A transistor-curve tracer such as the Tektronix Type 576 will give the most complete information.

2. **DC Voltmeter and Ohmmeter**—A voltmeter for checking voltages within the circuit and an ohmmeter for checking resistors and diodes are required.

3. **Test Oscilloscope**—A test oscilloscope is required to view waveforms at different points in the circuit.

A Tektronix 7000-series Oscilloscope with 7D13 Digital Multimeter unit, 7B-series Time-Base unit, and a 7A-series Amplifier unit with a 10X probe will meet the needs for items 2 and 3.

Troubleshooting Procedure

This troubleshooting procedure is arranged in an order which checks the simple trouble possibilities before proceeding with extensive troubleshooting.

1. **Check Control Settings.** Incorrect settings of the 7D11 controls can indicate a trouble that does not exist. If there is any question about the correct function or operation of a control or front-panel connector, see the Operating Instructions section.

2. **Check Associated Equipment.** Before proceeding with troubleshooting of the 7D11, check that the equipment used with this instrument is operating correctly. If possible, substitute a 7D11 known to be operating correctly into the indicator unit and see if the problem persists. Check that the inputs are properly connected and that the interconnecting cables are not defective.

3. **Visual Check.** Visually check the portion of the instrument in which the trouble is suspected. Many troubles can be located by visual indications, such as unsoldered connections, broken wires, damaged circuit boards, damaged components, etc.

4. **Check Instrument Performance.** Check the calibration of the unit, or the affected circuit by performing the performance check of Section 4. The apparent trouble may only be a result of misadjustment and may be corrected by calibration. Complete calibration instructions are given in Section 4.

5. **Check Voltages and Waveforms.** Often the defective component or stage can be located by checking for the correct voltage or waveform in the circuit. Typical voltages and waveforms are given on the diagrams; however, these are not absolute and may vary slightly between instruments. To obtain operating conditions similar to those used to take these readings, see the instructions in the Diagrams section.

6. **Check Individual Components.** The following methods are provided for checking the individual components in the 7D11. Components which are soldered in place are best checked by disconnecting one end to isolate the measurement from the effects of surrounding circuitry.

A. TRANSISTORS AND INTEGRATED CIRCUITS. The best check of transistor and integrated circuit operation is actual performance under operating conditions. If a transistor or integrated circuit is suspected of being defective, it can best be checked by substituting a component known to be good; however, be sure that circuit conditions are not such that a replacement might also be damaged. If substitute transistors are not available, use a dynamic tester (such as Tektronix Type 576). Static-type testers may be used, but since they do not check operation under simulated operating conditions, some defects may go unnoticed. Be sure the power is off before attempting to remove or replace any transistor or integrated circuit.

Integrated circuits can be checked with a voltmeter, test oscilloscope, or by direct substitution. A good understanding of the circuit description is essential to troubleshooting circuits using integrated circuits. Use care when checking voltages and waveforms around the integrated circuits so that adjacent leads are not shorted together. An integrated-circuit test clip provides a convenient means of clipping a test probe to the 14- and 16-pin integrated circuits. This device also doubles as an integrated-circuit extraction tool.

B. DIODES. A diode can be checked for an open or for a short circuit by measuring the resistance between termi-

nals with an ohmmeter set to the R X 1k scale. The diode resistance should be very high in one direction and very low when the meter leads are reversed. Do not check tunnel diodes or back diodes with an ohmmeter.

CAUTION

Do not use an ohmmeter scale that has a high internal current. High currents may damage the diodes.

C. RESISTORS. Check resistors with an ohmmeter. Resistor tolerance is given in the Electrical Parts List. Resistors normally do not need to be replaced unless the measured value varies widely from the specified value.

D. CAPACITORS. A leaky or shorted capacitor can be detected by checking resistance with an ohmmeter on the highest scale. Use an ohmmeter which will not exceed the voltage rating of the capacitor. The resistance reading should be high after initial charge of the capacitor. An open capacitor can best be detected with a capacitance meter, or by checking whether the capacitor passes AC signals.

7. Repair and Readjust the Circuit. Be sure to check the performance of any circuit that has been repaired or that has had any electrical components replaced. Recalibration of the affected circuit may be necessary.

REPLACEMENT PARTS

Standard Parts

All electrical and mechanical part replacements for the 7D11 can be obtained through your local Tektronix Field Office or representative. However, many of the standard electronic components can be obtained locally in less time than is required to order them from Tektronix, Inc. Before purchasing or ordering replacement parts, check the parts list for value, tolerance, rating, and description.

NOTE

When selecting replacement parts, it is important to remember that the physical size and shape of the component may affect its performance in the instrument. All replacement parts should be direct replacements unless it is known that a different component will not adversely affect the instrument performance.

Transistor and Integrated Circuit Replacement

Transistors and IC's should not be replaced unless they are actually defective. If removed from their sockets during routine maintenance, return them to their original sockets. Special care must be given to integrated circuit leads, because they can easily be damaged in removal from sockets. Unnecessary replacement or switching of components may affect the calibration of the instrument. When a transistor is replaced, check the operation of the part of the instrument that may be affected.

Recalibration After Repair

After any electrical component has been replaced, the calibration of that particular circuit should be checked, as well as the calibration of other closely related circuits. The Performance Check instructions given in Section 4 provide a quick and convenient means of checking the instrument operation. The adjustment procedure in Section 4 can then be used to adjust the operation to meet the Performance Requirements listed in Section 1.

Special Parts

Some parts are manufactured or selected by Tektronix to satisfy particular requirements, or are manufactured for Tektronix to our specifications. Most of the mechanical parts used in this instrument have been manufactured by Tektronix. Order all special parts directly from your local Tektronix Field Office or representative.

Ordering Parts

When ordering replacement parts from Tektronix, Inc., refer to the Parts Ordering Information and Special Notes and Symbols on the page immediately preceding the Electrical Parts List section. Include the following information:

1. Instrument type (7D11).
2. Instrument Serial Number.
3. A description of the part (if electrical, include the circuit number).
4. Tektronix Part Number.

Repackaging for Shipment

If the Tektronix instrument is to be shipped to a Tektronix Service Center for service or repair, attach a tag showing: owner (with address) and the name of an individual at your firm that can be contacted, complete instrument serial number and a description of the service required.

Save and re-use the package in which your instrument was shipped. If the original packaging is unfit for use or not available, repackage the instrument as follows:

Surround the instrument with polyethylene sheeting to protect the finish of the instrument. Obtain a carton of corrugated cardboard of the correct carton strength and having inside dimensions of no less than six inches more than the instrument dimensions. Cushion the instrument by tightly packing three inches of dunnage or urethane foam between carton and instrument, on all sides. Seal the carton with shipping tape or industrial stapler.

The carton test strength for your instrument is 200 pounds.

CALIBRATION

Calibration Interval

To ensure instrument accuracy, check the calibration of the 7D11 every 1000 hours of operation, or every six months if used infrequently.

Tektronix Field Service

Tektronix, Inc. provides complete instrument repair and recalibration at local Field Service Centers and the Factory Service Center. Contact your local Tektronix Field Office or representative for further information.

Using This Procedure

General. This section provides several features to facilitate calibration of the 7D11. These are:

Index. An index is given preceding the Calibration procedure to aid in locating steps.

Performance Check. The performance of this instrument can be checked by performing only the ✓ CHECK steps. The ✓ preceding a step indicates that performing this step checks the instrument against the tolerances listed as a Performance Requirement (see Specification section in 7D11 Operators Manual). Limits and tolerances given in other check steps are calibration guides and should not be interpreted as instrument specifications. Operator front-panel adjustments are adjusted as part of the performance check procedure.

Partial Calibration. A partial calibration is often desirable after replacing components, or to touch up the adjustment of a portion of the instrument between major recalibrations. To calibrate only part of the instrument, start with the nearest Equipment Required list preceding the desired portion. To prevent unnecessary recalibration of other parts of the instrument, re-adjust only if the tolerance given in the CHECK—part of the step is not met. If re-adjustment is necessary, also check the calibration of any steps listed in the INTERACTION—part of the step.

Complete Calibration Procedure. Completion of each step in the Calibration procedure ensures that this instrument is correctly adjusted and performing within all given tolerances.

TEST EQUIPMENT REQUIRED

General

The following test equipment and accessories, or equivalent, is required to completely check the 7D11. Specifications given for the test equipment are the minimum necessary. Therefore, some of the specifications listed here may be somewhat less precise than the actual performance capabilities of the recommended equipment. All test equipment is assumed to be correctly calibrated and operating within the listed specifications.

The Calibration procedure is based on the first item given as an example of applicable equipment. If other equipment is substituted, control settings or setup may need to be altered. Detailed operating instructions and the connections for the test equipment are not given in this procedure. Refer to the applicable instruction manual if more information is needed.

Test Equipment Alternatives

If the exact item of test equipment given as the first example is not available, first check the specifications column carefully to see if any other equipment is available which might suffice. Then check the Usage column to see what this item of equipment is used for. If used for a check which is of little or no importance to your measurement requirements, the item and corresponding step(s) can be deleted. For example, if the 7D11 is to be used only in a three-plug-in mainframe, delete the checks which require the use of a four-plug-in mainframe.

Signal Connections

Detailed signal-connection information is not given in this procedure except when critical for the particular test. In general, the front-panel DLY'D TRIG OUT and DLY INTERVAL OUT connectors should be connected to other equipment with 50-ohm BNC cables. The output of these cables should be terminated in 50 ohms; use a 50-ohm BNC termination if the other equipment has a high input impedance. Use a BNC, T connector to simultaneously connect a signal to two inputs. Signal-connection information for the test equipment should be available in the associated instruction manual.

TABLE 4-1
TEST EQUIPMENT

Description	Minimum Specifications	Usage	Examples of Applicable Test Equipment
1. Indicator mainframe	Equipped with a readout system; must be capable of accommodating four plug-in units for complete procedure as written.	Used throughout procedure to provide readout display. Also used with amplifier and time-base units as a test-oscilloscope system.	a. Tektronix 7904 Oscilloscope. b. Tektronix 7704A Oscilloscope. c. Any other Tektronix 7000-series oscilloscope equipped with a readout system. Must accommodate four plug-in units.
2. Time-base plug-in unit	Sweep rates, 20 milliseconds/division to magnified or delayed-sweep rate of 20 nanoseconds/division; accuracy, within 5%.	Used throughout procedure to provide sweep for the indicator mainframe.	a. Tektronix 7B92 Dual Time Base. b. Tektronix 7B70 or 7B71 Time Base.
3. Amplifier plug-in unit	Combined risetime of amplifier unit and indicator mainframe, DC to 50 megahertz; deflection factor, variable from 50 millivolts to five volts/division; accuracy, within 3%.	Triggering adjustments.	a. Tektronix 7A19 Amplifier. b. Tektronix 7A18 Dual-Trace Amplifier.
4. Dual-trace amplifier unit	Bandwidth (combined with indicator mainframe), DC to 50 megahertz; deflection factor, variable from 50 millivolts to five volts/division; accuracy, within 3%.	Used throughout procedure to provide internal trigger input to 7D11 and for vertical input to indicator mainframe for test oscilloscope use.	a. Tektronix 7A18 Dual-Trace Amplifier. b. Tektronix 7A12 Dual-Trace Amplifier.
5. Wide-band amplifier unit or test oscilloscope	Combined risetime of amplifier unit and indicator mainframe, less than two nanoseconds; deflection factor, 200 to 500 millivolts/division; accuracy, within 3%.	Front-panel outputs (risetime and falltime).	a. Tektronix 7A19 Amplifier. b. Tektronix 7A11 Amplifier. c. Test Oscilloscope, real-time or sampling, with suitable risetime.
6. Low-frequency signal generator	Sine-wave output; frequency range, 30 hertz to 150 kilohertz; output amplitude variable from 50 millivolts to 3.5 volts peak-to-peak.	Triggering checks and adjustments.	a. Tektronix FG501 Function Generator. ¹ b. General Radio 1310B Oscillator.
7. Medium-frequency signal generator	Sine-wave output; frequency range, 50 kilohertz and 0.9 to 50 megahertz; output amplitude, variable from 50 millivolts to one volt peak-to-peak into 50 ohms.	Triggering checks and adjustments. Recycle time checks. Front-panel delay interval output check. Time external clock check.	a. Tektronix SG 503 Signal Generator. ¹

¹ Requires TM 500-Series Power Module.

TEST EQUIPMENT (cont)

Description	Minimum Specifications	Usage	Examples of Applicable Test Equipment
8. Time-mark generator	Marker outputs, one second to ten microseconds; trigger output, one millisecond; marker accuracy, within 0.1%; marker amplitude, 0.5 volt into 50 ohms; trigger amplitude, 0.5 volt into 50 ohms.	Used throughout procedure to provide accurate time reference.	a. Tektronix TG501 Time-Mark Generator. ¹ b. Tektronix 2901 Time-Mark Generator.
9. Square-wave generator	Negative-going output: Amplitude, 15 volts into 50 ohms; repetition rate, one kilohertz; risetime, less than 12 nanoseconds. Positive-going output: Amplitude, 500 millivolts into 50 ohms; repetition rate, one megahertz; risetime, one nanosecond or less.	External trigger input compensation. Recycle timing adjustment. Fine delay range adjustment. Insertion delay time check.	a. Tektronix Type 106 Square-Wave Generator. b. Tektronix Type 284 Pulse Generator for positive-going output only.
10. Frequency standard	Frequency, one megahertz; accuracy, within 0.05 part per million; long-term drift, one part or less in 10 ⁸ per month.	Crystal oscillator frequency adjustment.	a. Any frequency standard calibrated to the National Bureau of Standards transmissions.
11. 10X Passive probe	Compatible with amplifier unit used.	Used throughout procedure to make measurements within the 7D11.	a. Tektronix P6053 Probe.
12. Plug-in extender	Flexible extender for 7000-series plug-in units.	Used throughout procedure to gain access to adjustments and test points.	a. Tektronix Part No. 067-0616-00.
13. Integrated-circuit (IC) Probe Tip	Provides means of applying probe tip to integrated-circuit pins.	Recycle timing adjustment. Crystal oscillator frequency adjustment.	a. Tektronix Part No. 015-0201-01. (Supplied as standard accessory with most Tektronix miniature passive probes.)
14. Attenuator	Impedance, 50 ohms; attenuation, 10X; connectors, BNC.	External trigger input compensation.	a. Tektronix Part No. 011-0059-02.
15. Termination (two required)	Impedance, 50 ohms; accuracy, ± 2%; connectors, BNC.	External trigger input compensation. Fine delay range adjustment.	a. Tektronix Part No. 011-0049-01.
16. Input RC normalizer	Time constant, one megohm X 20 picofarads; attenuation, 2X; connectors, BNC.	External trigger input compensation.	a. Tektronix Part No. 067-0538-00.
17. T connector	Connectors, BNC.	Used throughout procedure to simultaneously connect signals to two inputs.	a. Tektronix Part No. 103-0030-00.
18. Cable (two required)	Impedance, 50 ohms; type, RG-58/U; length, 18 inches; connectors, BNC.	Used throughout procedure for signal interconnection. Two equal length cables required for fine delay range adjustment.	a. Tektronix Part No. 012-0076-00.

¹ Requires TM 500-Series Power Module.

TEST EQUIPMENT (cont)

Description	Minimum Specifications	Usage	Examples of Applicable Test Equipment
19. Screwdriver	Three-inch shaft; 3/32-inch bit.	Used to adjust variable resistors.	a. Xcelite R-3323.
20. Low-capacitance screwdriver	1 1/2-inch shaft.	Used to adjust variable capacitors.	a. Tektronix Part No. 003-000-00.
21. Tuning tool handle		Handle for inserts (see 22 and 23).	a. Handle for 003-0310-00 and 003-0334-00 inserts. Tektronix Part No. 003-0307-00.
22. Tuning-tool insert	Adjusts variable capacitors.	Oscillator error voltage adjustment.	a. Tektronix Part No. 003-0334-00.
23. Tuning-tool insert	For 5/64-inch (ID) hex cores.	Crystal oscillator frequency adjustment.	a. Tektronix Part No. 003-0310-00.

CALIBRATION PROCEDURE INTRODUCTION

7D11, Serial No. _____
 Calibration Date _____
 Calibrated By _____

- √6. Check Internal Trigger Sensitivity (R151) Page 4-8
- √7. Check External Trigger Sensitivity Page 4-9
- √8. Check Trigger Level Control Range Page 4-10
- √9. Check Line Source Trigger Page 4-10

The following procedure returns the 7D11 to correct calibration. All limits and tolerances given in this procedure are calibration guides, and should not be interpreted as instrument specifications except as listed as a Performance Requirement in the Operators manual.

Index to Calibration Procedure

Digital Readout Display

- √1. Check Delay-by-Time Readout Page 4-6
- √2. Check Delay-by-Events Readout Page 4-6

Triggering

- 3. Adjust Trigger DC Balance (R77) Page 4-7
- 4. Adjust External Trigger DC Balance (R49) Page 4-8
- √5. Adjust External Trigger Input Compensation (C24, C10) Page 4-8

Events Count Mode

- √10. Check Events Start Trigger Sensitivity Page 4-11
- √11. Check Events Start Trigger Level Range Page 4-12
- 12. Adjust Recycle Timing (C589, C598) Page 4-12
- √13. Check Maximum Recycle Time Page 4-12
- 14. Adjust Arming TD Bias (R161) Page 4-13
- √15. Check Events Count Mode Operation Page 4-13

Time Count Mode

- √16. Adjust Crystal Oscillator Frequency Page 4-14
- 17. Adjust Oscillator Error Voltage Page 4-15
- √18. Check Time Ext 1 MHz Operation Page 4-15

- √19. Adjust Normal-Mode Insertion Delay and Fine Delay Range (R333, R331) Page 4-16
- √20. Check Echo-Mode Insertion Delay and Delay Time Accuracy Page 4-17
- √21. Check Delay Jitter Page 4-17
- √22. Check Recycle Time Page 4-17

Output Signals

- √23. Check Front-Panel Delay Interval Output Page 4-19
- 24. Check Delay Interval Outputs to Mainframe Page 4-20
- √25. Check Front-Panel Delayed Trigger Output Page 4-20
- √26. Check Delayed Trigger Output to Mainframe Page 4-21
- √27. Check Delayed Trigger and Delay Interval Coincidence Page 4-21

- √28. Check B Sweep Delay Mode Operation Page 4-22

NOTE

Titles for external controls and connectors of this instrument are capitalized in this procedure (e.g., COUNT MODE). Internal switches and adjustments are initial capitalized only (e.g., Delay Time Mode).

Preliminary Procedure

1. Remove both side covers from the 7D11. Set the internal Normal-Echo Delay Time Mode switch to Normal and the Z-Axis Blanking Display switch to Non-Intensified (both switches in the forward position).

2. Install the 7D11 in the indicator mainframe according to the Set-Up Instructions preceding the portion of the procedure to be performed.

DIGITAL READOUT DISPLAY

Equipment Required

1. Indicator mainframe.

BEFORE YOU BEGIN, see ADJUSTMENT LOCATIONS in the Diagrams section.

Set-Up

Install the 7D11 in any plug-in compartment of the mainframe. Set the controls as follows:

TRIGGER	
SLOPE	+
LEVEL	Clockwise
COUPLING	AC
SOURCE	EXT
EVENTS START TRIGGER	
SLOPE	-
LEVEL	Clockwise
B SWEEP DELAY MODE	INDEPENDENT
COUNT MODE	TIME INT CLOCK
FINE DELAY	0.0

✓1. Check Delay-by-Time Readout

✓a. CHECK—Display in the upper readout area of the CRT for 0.0001+; check the display in the lower readout area for mS.

✓b. CHECK—Rotate the DELAY TIME OR EVENTS control clockwise. The delay-time readout should increase in value while the control is held in this position. Check that the rate of change increases as this control is turned further clockwise.

✓c. CHECK—Rotate the DELAY TIME OR EVENTS control counterclockwise. The delay-time readout should decrease in value while the control is held in this position. Check that the rate of change increases as this control is turned further counterclockwise.

✓2. Check Delay-by-Events Readout

a. Reset the 7D11 to 0.0001+ mS by pressing the RESET pushbutton.

b. Set the COUNT MODE switch to EVENTS.

✓c. CHECK—Readout display for an events-count readout of 0000001 in the upper readout area of the CRT.

✓d. CHECK—Rotate the DELAY TIME OR EVENTS control clockwise. The number-of-events count should increase while the control is held in this position.

✓e. CHECK—Rotate the DELAY TIME OR EVENTS control counterclockwise. The number-of-events count should decrease while the control is held in this position.

f. Remove the 7D11 from the mainframe.

TRIGGERING

Equipment Required

- | | |
|--|---------------------------------|
| 1. Indicator mainframe | 7. Square-wave generator |
| 2. Amplifier plug-in unit (two required) | 8. 10X BNC attenuator |
| 3. Time-base plug-in unit | 9. 50-ohm BNC termination |
| 4. Low-frequency signal generator | 10. 20-pF normalizer |
| 5. 10X probe | 11. Three-inch screwdriver |
| 6. Flexible plug-in extender | 12. Low-capacitance screwdriver |

BEFORE YOU BEGIN, see ADJUSTMENT LOCATIONS in the Diagrams section.

Set-Up

In the indicator mainframe, install amplifier units in both vertical compartments and a time-base unit in either horizontal compartment. Place the 7D11 on the plug-in extender, and plug the extender into the other horizontal compartment. Set the 7D11 controls as follows:

TRIGGER	
SLOPE	+
LEVEL	Clockwise
COUPLING	AC
SOURCE	INT
EVENTS START TRIGGER	
SLOPE	—
LEVEL	Clockwise
B SWEEP DELAY MODE	INDEPENDENT
COUNT MODE	TIME INT CLOCK
FINE DELAY	0.0

3. Adjust Trigger DC Balance

- a. Set the mainframe to display the time-base unit and for a dual-trace vertical display in the alternate mode.
- b. Set the time-base unit for a free-running sweep at a rate of one microsecond/division.
- c. Connect the low-frequency signal generator to one of the amplifier units and to the EXT TRIG IN connector.
- d. Set the signal generator and amplifier unit for a 0.5-division display of a 50-kilohertz signal, vertically centered on the graticule area. Do not change the vertical position of the display for the remainder of step 3.

e. Set the mainframe to select the 50-kilohertz signal channel as the internal trigger source for both the 7D11 and the time-base unit.

f. Connect a 10X probe to the other amplifier unit. Set this amplifier unit for a deflection factor of 20 millivolts/division (200 millivolts/division at probe tip) and DC input coupling.

g. Connect the probe tip to TP 130 on the Trigger board.

h. Set the time-base unit for auto, internal triggering at a five-microsecond/division sweep rate.

i. Set the TRIGGER LEVEL control for a TP 130 waveform with approximately equal positive and negative half cycles (50% duty cycle).

j. Set the TRIGGER SLOPE switch to —. If necessary, compromise the setting of the TRIGGER LEVEL control for a TP 130 waveform with approximately equal positive and negative half cycles in the + and — positions of the TRIGGER SLOPE switch. Do not change the setting of the TRIGGER LEVEL control for the remainder of step 3.

NOTE

When the conditions given in step 3j are met, the dot on the TRIGGER LEVEL knob should be aligned with the 0 on the front panel. Component replacement or knob removal might necessitate re-alignment. If so, loosen the setscrew and reposition the knob.

Calibration—7D11 Service

k. Set the 7D11 COUPLING switch to DC.

l. CHECK—Display of TP 130 waveform for approximately equal positive and negative half cycles.

m. ADJUST—DC Balance adjustment R77 for a TP 130 waveform with approximately equal positive and negative half cycles.

4. Adjust External Trigger DC Balance

a. Set the amplifier unit with the 50-kilohertz signal applied for a deflection factor of 50 mV/division.

b. Set the low-frequency signal generator for a three-division display (150 millivolts).

c. Set the SOURCE switch to EXT.

d. CHECK—Display of the TP 130 waveform for approximately equal positive and negative half cycles.

e. ADJUST—External DC Balance adjustment R49 for a display with approximately equal positive and negative half cycles.

f. Disconnect all test equipment. Leave the 10X probe connected to the amplifier unit.

√5. Adjust External Trigger Input Compensation

a. Connect the probe tip to TP 41. Set the amplifier unit for a deflection factor of 10 millivolts/division (100 millivolts/division at probe tip).

b. Set the other amplifier unit for a deflection factor of 0.1 volt/division.

c. Set the time-base unit for auto, internal triggering at a sweep rate of 500 microseconds/division.

d. Connect the high-amplitude output of the square-wave generator to the amplifier unit through a 10X attenuator, 50-ohm termination, and 20-pF normalizer.

e. Set the square-wave generator for a five-division display (0.5 volt) at a one-kilohertz repetition rate.

f. Disconnect the square-wave generator from the amplifier unit and connect it to the EXT TRIG IN connector through the 10X attenuator, 50-ohm termination, and 20-pF normalizer.

g. Set the mainframe to select the vertical channel with the 10X probe for display and trigger source for the time-base unit.

√h. CHECK—Display for square wave with flat top and square front corner.

i. ADJUST—C24 for optimum square front corner.

j. Set the SOURCE switch to EXT ÷ 10.

k. Remove the 10X attenuator from the signal connection to the EXT TRIG IN connector.

√l. CHECK—Displayed square wave for flat top and optimum square corner. Disregard the spike on the leading edge of displayed square wave.

m. ADJUST—C10 (on TRIGGER SOURCE switch) for optimum square corner on displayed square wave. Disregard the spike on the leading edge of displayed square wave.

n. Disconnect all test equipment.

√6. Check Internal Trigger Sensitivity

a. Set the 7D11 SOURCE switch to INT.

b. Connect the low-frequency signal generator to the amplifier-unit input. Set the mainframe to display this amplifier unit.

c. Connect the DLY'D TRIG OUT connector to the time-base unit external trigger input.

d. Set the time-base unit for auto, external triggering at a sweep rate of 10 milliseconds/division.

e. Set the amplifier-unit deflection factor and the signal generator for a 0.3-division display at 30 hertz. (A 0.3-division display amplitude can easily be obtained by setting the display for three divisions and increasing the deflection factor ten times.)

f. Set the mainframe to select the amplifier unit as the internal trigger source for the 7D11.

g. Set the 7D11 TRIGGER LEVEL control to light the TRIG'D indicator. Set the time-base unit trigger controls for a stable display.

√h. CHECK—A stable display can be obtained in both the + and - positions of the TRIGGER SLOPE switch (it

might be necessary to reset the TRIGGER LEVEL control for a stable display).

√i. CHECK—Using Table 4-2 as a guide, check for each condition given in both the + and – positions of the TRIGGER SLOPE switch. It might be necessary to reset the TRIGGER LEVEL control to obtain a stable display after changing the coupling or TRIGGER SLOPE switch setting. Set the time-base unit sweep rate for optimum viewing of the display.

TABLE 4-2

7D11 COUPLING	Generator Frequency	Display Amplitude	Stable Display
AC	30 hertz	0.3 division	yes
AC HF REJ	30 hertz	0.3 division	yes
DC	30 hertz	0.3 division	yes
AC LF REJ	120 hertz	3 divisions	no
AC LF REJ	30 kilohertz	0.3 division	yes
AC HF REJ	50 kilohertz	0.3 division	yes

j. Disconnect the signal generator.

k. Connect the medium-frequency signal generator to the amplifier unit.

√l. CHECK—Using Table 4-3 as a guide, check for a stable display for each condition given in both the + and – TRIGGER SLOPE switch positions. Reset the TRIGGER LEVEL control as necessary to light the TRIG'D indicator and obtain a stable display. Set the time-base unit sweep rate for optimum viewing of the display.

TABLE 4-3

7D11 COUPLING	Generator Frequency	Display Amplitude
AC	10 megahertz	0.3 division
AC LF REJ	10 megahertz	0.3 division
DC	10 megahertz	0.3 division
AC	50 megahertz	1.0 division
AC LF REJ	50 megahertz	1.0 division
DC	50 megahertz	1.0 division

m. ADJUST—If necessary, adjust the Delay Start TD Bias adjustment R151 for a stable display of the 50-megahertz signal.

n. Disconnect all test equipment (leave DLY'D TRIG OUT connected to the time-base unit for next step).

√7. Check External Trigger Sensitivity

a. Set the 7D11 SOURCE switch to EXT and the COUPLING switch to AC.

b. Connect the low-frequency signal generator to the amplifier-unit input and to the EXT TRIG IN connector.

c. Connect the DLY'D TRIG OUT connector to the time-base unit external trigger input. Set the time-base unit for a 10 millisecond/division sweep rate.

d. Set the amplifier unit for a calibrated deflection factor of 50 millivolts/division.

e. Set the signal generator for a three-division display (150 millivolts) at 30 hertz.

f. Set the 7D11 TRIGGER LEVEL control to light the TRIG'D indicator. Set the time-base unit trigger controls for a stable display.

√g. CHECK—Stable display can be obtained with the TRIGGER SLOPE control set to the + and – positions (resetting the TRIGGER LEVEL control might be required).

√h. CHECK—Using Table 4-4 as a guide, check for each condition given in both the + and – positions of the TRIGGER SLOPE switch. It might be necessary to reset the TRIGGER LEVEL control to obtain a stable display. Set the time-base unit sweep rate for optimum viewing of the display.

TABLE 4-4

7D11 COUPLING	Generator Frequency	Sine-Wave Amplitude
AC	30 hertz	150 millivolts
AC HF REJ	30 hertz	150 millivolts
DC	30 hertz	150 millivolts
AC LF REJ	150 kilohertz	150 millivolts
AC HF REJ	50 kilohertz	150 millivolts

i. Disconnect the low-frequency signal generator. Connect the medium-frequency signal generator to the amplifier-unit input and to the EXT TRIG IN connector.

Calibration—7D11 Service

√j. CHECK—Using Table 4-5 as a guide, check for a stable display for each condition given in both the + and – TRIGGER SLOPE switch positions. Reset the TRIGGER LEVEL control as necessary for a stable display. Set the time-base unit sweep rate for optimum viewing of the display.

TABLE 4-5

7D11 COUPLING	Generator Frequency	Sine-Wave Amplitude
AC	10 megahertz	150 millivolts
AC LF REJ	10 megahertz	150 millivolts
DC	10 megahertz	150 millivolts
DC	50 megahertz	500 millivolts
AC LF REJ	50 megahertz	500 millivolts
AC	50 megahertz	500 millivolts

k. Disconnect the medium-frequency signal generator. Retain the connection between the 7D11 and the time-base unit for the next step.

√8. Check 7D11 Trigger Level Control Range

- Set the COUPLING switch to AC.
- Set the amplifier unit for a calibrated deflection factor of .5 volt/division and the time-base unit for a sweep rate of 10 microseconds/division.
- Connect the low-frequency signal generator to the EXT TRIG IN connector and to the amplifier unit.

d. Set the signal generator for a seven-division display 3.5 volts, peak-to-peak at 50 kilohertz.

√e. CHECK—Rotate the TRIGGER LEVEL control throughout its range and check that the delay can be triggered at any point on the positive-going slope of the waveform. Set the TRIGGER SLOPE switch to – and repeat this check for the negative-going slope of the waveform (TRIGGER LEVEL range, at least +1.75 volts to –1.75 volts).

f. Disconnect all test equipment. Retain the connection between the 7D11 and the time-base unit for the next step.

√9. Check Line Source Trigger

- Set the SOURCE switch to LINE.
- Set the time-base unit for a sweep rate of five milliseconds/division and the amplifier unit for a deflection factor of five or ten volts/division.
- Connect a 10X probe to the amplifier-unit input. Connect the probe tip to a line-voltage source.
- √d. CHECK—Set the TRIGGER LEVEL control to light the TRIG'D indicator and check for a stable display.
- Disconnect the 10X probe. Remove all plug-in units from the mainframe.

EVENTS COUNT MODE

Equipment Required

- | | |
|--|---------------------------------------|
| 1. Indicator mainframe | 6. 10X probe |
| 2. Amplifier plug-in unit (dual-trace) | 7. Low-capacitance screwdriver |
| 3. Time-base plug-in unit | 8. IC probe tip |
| 4. Flexible plug-in extender | 9. Three-inch screwdriver |
| 5. Square-wave generator | 10. Medium-frequency signal generator |
| | 11. Low-frequency signal generator |

BEFORE YOU BEGIN, see **ADJUSTMENT LOCATIONS** in the *Diagrams* section.

Set-Up

In the indicator mainframe, install a dual-trace amplifier unit in either vertical compartment and a time-base unit in either horizontal compartment. Within the 7D11, disconnect P213 from the RF circuit board. Loosen the securing screws and remove the RF board from the unit. Place the 7D11 on the plug-in extender and plug the extender into the remaining vertical compartment. Set the 7D11 controls as follows:

TRIGGER	
SLOPE	+
LEVEL	Clockwise
COUPLING	AC
SOURCE	EXT
EVENTS START TRIGGER	
SLOPE	—
LEVEL	Clockwise
B SWEEP DELAY MODE	INDEPENDENT
COUNT MODE	EVENTS
FINE DELAY	0.0

✓10. Check Events Start Trigger Sensitivity

- Set the mainframe to display the amplifier and time-base units.
- Set the amplifier unit for dual-trace operation in the chopped mode.
- Connect a 10X probe to one of the amplifier-unit inputs. Check the probe compensation. Set this channel for a deflection factor of 50 millivolts/division (500 millivolts/division at probe tip).
- Connect the probe tip to TP 638 (on Logic board, near the front of the unit).
- Connect the medium-frequency signal generator to the EVENTS START TRIG IN connector and to the other input of the amplifier unit.

f. Set the signal generator for a 100-millivolt output at two megahertz.

g. Set the time-base unit for auto, internal triggering at a 500 nanosecond/division sweep rate.

✓h. CHECK—Check that a display of the trigger-circuit output can be obtained with the EVENTS START TRIGGER LEVEL control set at or near zero (midrange) in both positions of the EVENTS START TRIGGER SLOPE switch. Check also with the signal generator set for a 250 millivolt output at 20 megahertz and a 500 millivolt output at 50 megahertz for instruments above SN B050000 (300 millivolt at 4 megahertz and a 600 millivolt output at 50 megahertz for instruments below SN B050000).

NOTE

When the conditions given in step 10h are met, the dot on the EVENTS START TRIGGER LEVEL knob should be aligned with the 0 on the front panel. Component replacement or knob removal might necessitate re-alignment. If so, loosen the setscrew and reposition the knob.

i. Disconnect the medium-frequency signal generator and connect the low-frequency signal generator to the EVENTS START TRIG IN connector and to the amplifier unit.

j. Set the low-frequency signal generator for a 100-millivolt output at 30 hertz. Set the time-base unit for a 10 millisecond/division sweep rate.

✓k. CHECK—Check that a display of the trigger-circuit output can be obtained with the EVENTS START TRIGGER LEVEL control set at or near zero (midrange) in both positions of the EVENTS START TRIGGER SLOPE switch.

✓11. Check Events Start Trigger Level Range

- a. Set the low-frequency generator for a six-volt output at 50 kilohertz.
- b. Set the amplifier unit to select the channel with the trigger-circuit output applied (10X probe) as the trigger source for the time-base unit.
- c. Set the time-base unit for a five-microsecond/division sweep rate and — slope triggering.
- d. Set the EVENTS START TRIGGER SLOPE switch to +.
- ✓e. CHECK—Rotate the EVENTS START TRIGGER LEVEL control throughout its range and check that a stable display can be obtained at any point on the positive-going slope of the sine wave. Set the EVENTS START TRIGGER SLOPE switch to — and repeat this check for the negative-going slope of the sine wave (EVENTS START TRIGGER LEVEL range, at least + three volts to — three volts).
- f. Disconnect all test equipment. Leave the 10X probe connected to the amplifier unit.

NOTE

Instruments above serial number B050000 have been modified at the factory to facilitate the Recycle Timing adjustment. This modification consists of changing the value of R591 on A4, Interface circuit board (see Fig. 6-7 in the Diagrams section) to 8.25 k. If the instrument being calibrated is below serial number B050000 and has not been modified previously, this change should be made before proceeding. The following procedure is for modified instruments only.

12. Adjust Recycle Timing

- a. Set the EVENTS START TRIGGER SLOPE switch to +.
- b. Set the time-base unit for auto, internal triggering at a one-millisecond/division sweep rate.
- c. Connect the fast-rise, positive-transition output of the square-wave generator to the amplifier unit. Set this channel of the amplifier unit for a deflection factor of 100 millivolts/division with DC input coupling.
- d. Set the square-wave generator for a five-division display (500 millivolts) of a fast-rise square wave at a one-megahertz repetition rate.
- e. Disconnect the generator from the amplifier unit and connect it to the EXT TRIG IN and EVENTS START TRIG IN connectors.

f. Set the amplifier unit to display the channel with the 10X probe. Set this channel for a deflection factor of 200 millivolts/division (two volts/division at probe tip).

g. Set the time-base unit for auto, internal triggering on the negative slope at a sweep rate of 100 nanoseconds/division.

h. Set the TRIGGER LEVEL control to light the TRIG'D indicator.

i. Connect the probe tip to pin 4 of U589 on the Interface circuit board.

j. Set the EVENTS START TRIGGER LEVEL control to obtain a square-wave display.

k. CHECK—Negative portion of displayed square wave for four divisions (400 nanoseconds) between the 50%-amplitude points on the falling and rising portion.

l. ADJUST—C589 for a negative portion of the displayed square-wave to be four divisions (400 nanoseconds) measured between the 50%-amplitude points.

m. Move probe to pin 4 of U598.

n. CHECK—Negative portion of displayed square-wave for 3.1 to 3.2 divisions (310 to 320 nanoseconds) between the 50%-amplitude points on the falling and rising portion.

o. ADJUST—C598 for the negative portion of the displayed square-wave to be 3.1 to 3.2 divisions (320 to 350 nanoseconds) measured between the 50%-amplitude points.

p. Disconnect all test equipment and the 10X probe.

✓13. Check Maximum Recycle Time

- a. Install the 7D11 in a VERT compartment and set the amplifier unit for single-channel operation.
- b. Set the mainframe for a dual-trace vertical display in the alternate mode, with the 7D11 selected as the internal trigger source for the time-base unit.
- c. Connect the medium-frequency signal generator to the EXT TRIG IN connector, EVENTS START TRIG IN connector, and to the amplifier unit.
- d. Set the signal generator for a 500-millivolt output at 1.6 megahertz.

e. Set the time-base unit for a 0.5-microsecond/division sweep rate.

f. Set the DELAY TIME OR EVENTS control for an events-count readout of 0000001 by pressing the RESET button. Set the TRIGGER LEVEL control to light the TRIG'D indicator and the EVENTS START TRIGGER LEVEL control to obtain one count for each cycle of the signal generator waveform (indicated by a Pedestal Display of one pulse per cycle of sine wave).

g. Increase the generator frequency until one count is obtained for each two cycles of the sine wave. Reset the TRIGGER LEVEL control while increasing the generator frequency to reach the highest possible frequency before the one count for each two cycles of sine wave is obtained.

√h. CHECK—Output frequency of the generator to be two megahertz or greater (indicates recycle time of 500 nanoseconds or less).

14. Adjust Arming TD Bias

a. Decrease the frequency of the signal generator to obtain one count per cycle of sine wave.

b. ADJUST—Arming TD Bias adjustment R161 (on Trigger Board) counterclockwise until the trace becomes unstable, then clockwise for a stable display.

c. Disconnect all test equipment.

√15. Check Events Count Mode Operation

a. Connect the marker output of the time-mark generator to the amplifier unit and to the EXT TRIG IN connector.

b. Connect the trigger output of the time-mark generator to the EVENTS START TRIG IN connector.

c. Set the time-mark generator for 0.1-millisecond markers and one-millisecond triggers.

d. Set the time-base unit for auto, internal triggering at a 0.1-millisecond/division sweep rate.

e. Set the DELAY TIME OR EVENTS control for an events-count readout of 0000002.

f. Set the TRIGGER LEVEL control to light the TRIG'D indicator.

g. Set the EVENTS START TRIGGER LEVEL control for a stable display.

√h. CHECK—CRT display for the positive portion of the Pedestal Display (near the vertical center of the CRT viewing area) to be coincident with the tenth and eleventh markers (see Fig. 4-1).

i. Disconnect all test equipment and remove the plug-in units from the mainframe. Replace the RF board in the 7D11.

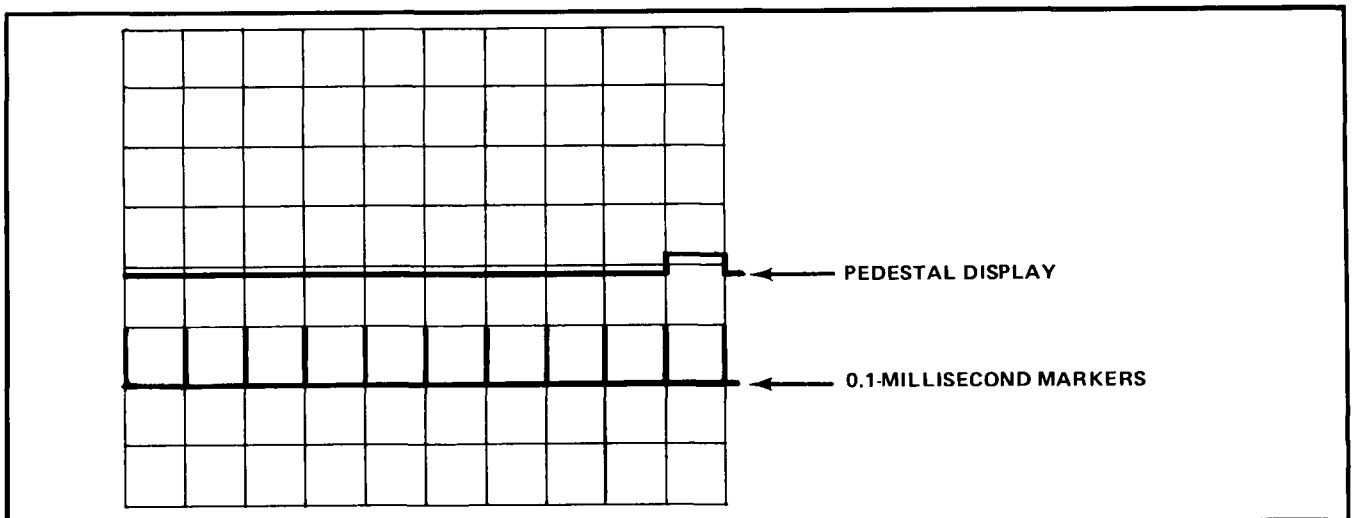

Fig. 4-1. Simulated waveforms showing display obtained to check Events Count Mode.

TIME COUNT MODE

Equipment Required

- | | |
|--|--|
| <ol style="list-style-type: none"> 1. Indicator mainframe 2. Dual-trace amplifier plug-in unit 3. Time-base plug-in unit 4. Flexible plug-in extender 5. Frequency standard 6. Time-mark generator 7. 10X probe 8. Tuning tool | <ol style="list-style-type: none"> 9. Non-metallic adjustment tool 10. Square-wave generator 11. BNC T connector 12. IC probe tip 13. 18-inch 50-ohm BNC cable (two cables of equal length required) 14. 50-ohm BNC termination (two required) 15. Three-inch screwdriver |
|--|--|

BEFORE YOU BEGIN, see ADJUSTMENT LOCATIONS in the Diagrams section.

Set-Up

In the indicator mainframe, install the dual-trace amplifier unit in either vertical plug-in compartment and a time-base unit in the B horizontal compartment. Place the 7D11 on the flexible plug-in extender and plug the extender into the remaining horizontal compartment. Set the mainframe to display the amplifier and time-base units.

Set the 7D11 controls as follows:

- | | |
|----------------------|----------------|
| TRIGGER | |
| SLOPE | + |
| LEVEL | Clockwise |
| COUPLING | AC |
| SOURCE | EXT |
| EVENTS START TRIGGER | |
| SLOPE | . |
| LEVEL | Clockwise |
| B SWEEP DELAY MODE | INDEPENDENT |
| COUNT MODE | TIME INT CLOCK |
| FINE DELAY | 0.0 |

a. Place the 7D11 with the left side on the bench so the crystal oscillator is facing downward. Allow the unit to warm up in this position for about 15 minutes.

b. Set the time-base unit for auto, external triggering at a 100-nanosecond/division sweep rate.

c. Connect the frequency-standard one-megahertz output to the external trigger input of the time-base unit.

d. Connect one-second markers from the time-mark generator to the external Z-axis input of the mainframe.

e. Connect the 10X probe to the amplifier unit. Set the amplifier unit for single-channel operation and check the probe compensation.

f. Set the amplifier unit for a deflection factor of 200 millivolts/division (two volts/division at probe tip).

g. Connect the probe tip to pin 8 of U205 on the RF circuit board.

✓16. Adjust Crystal Oscillator Frequency

NOTE

The Oscillator frequency must be adjusted at an ambient room temperature of about +25°C according to the following procedure to ensure operation within the limits given in the Specification for an operating temperature range of 0°C to +50°C.

✓h. CHECK—Note the crystal oscillator frequency at 27°C as printed on the crystal-oscillator cover. The error frequency (if any) is the difference from 5 megahertz. Divide the error frequency by five to obtain the Clock

error. Check the displayed waveform to drift horizontally at a rate of one division per second for each 0.1 hertz of Clock error. The display should drift to the right for a negative Clock error and to the left for a positive Clock error. (For example: A crystal oscillator with the frequency at 27°C of 5 MHz – 1.0 Hz will have a Clock error equal to –1.0 Hz/5 or – 0.20 hertz. The display should drift to the right at a rate of 2.0 divisions per second.)

i. ADJUST—Crystal oscillator frequency adjustment for a display as given in part h of this step. To gain access to the oscillator frequency adjustment, remove the screw in the oscillator cover. The adjustment is made with the tuning tool. Replace the screw in the cover and recheck for correct adjustment.

j. Disconnect all test equipment from the 7D11. Leave the 10X probe connected to the amplifier unit.

17. Adjust Oscillator Error Voltage

a. Set the time-base unit for a free-running sweep at a rate of 10 microseconds/division.

b. Set the amplifier unit for a deflection factor of 500 millivolts/division (five volts/division at probe tip).

c. Establish a zero-volt reference level for the trace by setting the amplifier-unit coupling to ground and vertically centering the trace.

d. Connect the probe tip to TP 240 on the RF board and set the amplifier unit for DC input coupling.

e. CHECK—Display for an average DC level of zero volts within 0.5 division (zero volts ± 2.5 volts).

f. ADJUST—C258 for a display with an average DC level of zero volts. C258 is accessible through a hole in the RF shield. Use a non-metallic adjustment tool.

g. Disconnect all test equipment.

✓18. Check Time Ext 1 MHz Operation

a. Set the time-base unit for auto, internal triggering at a one-millisecond/division sweep rate.

b. Connect the marker output of the time-mark generator to one of the amplifier-unit inputs.

c. Set the time-mark generator for ten-millisecond markers.

d. Set the B SWEEP DELAY MODE switch to B STARTS AFTER DELAY and the SOURCE switch to INT.

e. Set the mainframe and amplifier unit to select the time-mark signal as the internal trigger source for the 7D11.

f. Set the amplifier-unit deflection factor and the 7D11 TRIGGER controls for a stable display.

g. Set the DELAY TIME OR EVENTS control for a delay-time readout of 95.0000+ mS.

h. With the time-base unit position control, align the first displayed marker with the center vertical graticule line.

i. Connect the low or medium-frequency signal generator to the EXT 1 MHz IN connector.

j. Set the signal generator for a 400-millivolt, one-megahertz output.

k. Set the COUNT MODE switch to TIME EXT 1 MHz.

✓l. CHECK—The displayed time marker can be moved at least one division each side of the center vertical graticule line as the signal-generator frequency is slowly varied above and below one-megahertz (external clock frequency, one-megahertz within 1%).

m. Disconnect all test equipment.

✓19. Adjust Normal-Mode Insertion Delay and Fine Delay Range

- a. Set the COUNT MODE switch to TIME INT CLOCK and set the DELAY MODE switch to INDEPENDENT.
- b. Connect the fast-rise, positive-transition output of the square-wave generator to the EXT TRIG IN connector with a BNC T connector. Connect the output of the T connector to one of the amplifier-unit inputs with one of the 18-inch 50-ohm BNC cables and 50-ohm BNC termination.
- c. Connect the DLY'D TRIG OUT connector to the other input of the amplifier unit with the other 18-inch 50-ohm BNC cable and 50-ohm BNC termination (cable must be same length as used in part b).
- d. Connect the trigger output of the square-wave generator to the external trigger input of the time-base unit.
- e. Set the amplifier unit for dual-trace operation in the chopped mode. Set the mainframe for single vertical-channel operation.
- f. Set the time-base unit for auto, external triggering at a 200-nanosecond/division sweep rate.
- g. Set the square-wave generator for a fast-rise, 500 millivolt output at a one-megahertz repetition rate.

h. Set the DELAY TIME OR EVENTS control for a delay-time readout of 0.0001+ mS.

i. Set the 7D11 TRIGGER COUPLING to AC and SOURCE to EXT. Adjust the TRIGGER LEVEL control to light the TRIG'D indicator. Set the time-base unit trigger controls to start the sweep prior to the rising portion of the generator waveform.

j. Set both channels of the amplifier unit for DC input coupling. Set the deflection factors to display two or three divisions of the waveforms. Vertically center the waveforms.

k. Set the time-base unit for a sweep rate of 20 nanoseconds/division by pushing X10 MAG button to ON.

l. Set the 7D11 TRIGGER LEVEL control for minimum time between the rising portions of the two waveforms.

✓m. CHECK—Displayed waveforms for five divisions ± 0.1 division (100 nanoseconds within two nanoseconds) between the 50%-amplitude points on the rising portion. This indicates a Normal-Mode insertion delay of zero within two nanoseconds (see Fig. 4-2).

n. ADJUST—R333 for exactly five divisions (100 nanoseconds) between the 50%-amplitude points on the rising portion of the displayed waveforms.

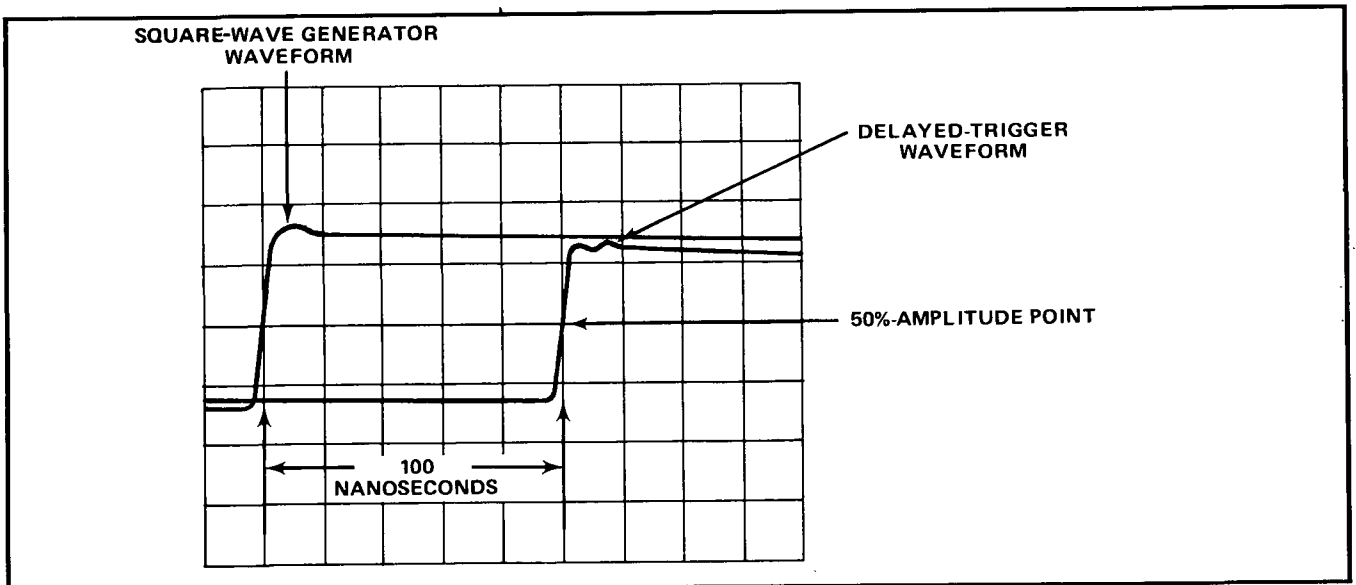

Fig. 4-2. Simulated waveforms showing display obtained to check Normal-Mode insertion delay.

o. Establish a zero-time reference by aligning the 50%-amplitude point on the rising portion of the Delayed Trigger pulse with the second vertical graticule line.

p. Set the FINE DELAY dial at 100.0.

√q. CHECK—The 50%-amplitude point on the rising portion of the Delayed Trigger pulse is within five divisions ± 0.1 division of the zero-time reference set in part n of this step (100 nanoseconds within two nanoseconds).

r. ADJUST—R331 to set the 50%-amplitude point on the rising portion of the Delayed Trigger pulse within five divisions of the zero-time reference set in part n of this step (100 nanoseconds).

s. Repeat the adjustment procedure for R333 and R331 until no interaction is noted.

t. Remove the extender from the mainframe and from the 7D11.

√20. Check Echo Mode Insertion Delay and Delay Time Accuracy

a. Set the Normal-Echo Mode switch to Echo (rear switch position; see Operating Information section) and install the 7D11 in the A horizontal plug-in compartment.

b. Set the FINE DELAY dial to 0.0.

c. Set the time-base unit for a sweep rate of 50 nanoseconds/division (sweep magnification not necessary).

d. CHECK—Displayed waveforms for less than 3.2 divisions between the 50%-amplitude points on the rising portion (Echo mode insertion delay less than 160 nanoseconds).

e. Set the FINE DELAY dial to obtain four divisions between the waveforms at the 50%-amplitude points on the rising portion (Echo mode insertion delay adjustable to 200 nanoseconds within four nanoseconds).

f. Set the DELAY TIME OR EVENTS control for a delay-time readout of 0.0002+ mS.

g. CHECK—Displayed waveforms for eight divisions ± 0.08 division between the 50%-amplitude points on the rising portion (400 nanoseconds within four nanoseconds).

h. Disconnect all test equipment.

i. Set the Normal-Echo Mode switch to Normal.

√21. Check Delay Jitter

a. Connect the marker output of the time-mark generator to the EXT TRIG IN connector and to one of the amplifier-unit inputs.

b. Connect the DLY'D TRIG OUT connector to the time-base unit external trigger input.

c. Set the time-mark generator for one-microsecond markers.

d. Set the amplifier unit to display at least four divisions of the markers (single-channel operation).

e. Set the time-base unit for a magnified sweep rate of ten nanoseconds/division (use basic sweep rate of 100 nanoseconds/division, magnified 10 times with X10 magnifier or delayed sweep to obtain 10 nanoseconds/division).

f. Set the 7D11 TRIGGER LEVEL control for a marker display with the least jitter (narrowest trace width).

√g. CHECK—CRT display for jitter of 0.25 division or less (delay jitter, 2.5 nanoseconds or less).

h. Set the DELAY TIME OR EVENTS control for a delay-time readout of 0.0010+ mS.

√i. CHECK—CRT display for jitter of 0.25 division or less (delay jitter, 2.5 nanoseconds or less).

j. Disconnect all test equipment.

√22. Check Recycle Time

a. Connect the medium-frequency signal generator to the EXT TRIG IN connector and to one of the amplifier-unit inputs.

Calibration—7D11 Service

b. Connect the DLY'D TRIG OUT connector to the other amplifier-unit input.

c. Set the time-base unit for auto, internal triggering at a sweep rate of 0.5 microsecond/division.

d. Set the DELAY TIME OR EVENTS control for a delay-time readout of 0.0001+ mS and set the FINE DELAY dial to 0.0.

e. Set the signal generator for a 400-millivolt output at 1.6 megahertz.

f. Set the amplifier unit for dual-trace operation in the chopped mode with the DLY'D TRIG OUT signal channel (connected in part b) selected for the internal trigger source.

g. Set the TRIGGER LEVEL control and the time-base unit to obtain a display of one Delayed Trigger pulse for each cycle of the sine wave.

h. Increase the generator frequency until one Delayed Trigger pulse is displayed for every two cycles of the sine wave.

√i. CHECK—Generator frequency must be 1.75 megahertz or higher (indicates recycle time of not greater than 575 nanoseconds).

j. Disconnect all test equipment. Remove the plug-in units from the mainframe.

OUTPUT SIGNALS

Equipment Required

- | | |
|--|---|
| <ol style="list-style-type: none"> 1. Indicator mainframe 2. Wide-band amplifier plug-in unit 3. Dual-trace amplifier plug-in unit 4. Time-base plug-in unit | <ol style="list-style-type: none"> 5. Time-mark generator 6. Two 18-inch 50-ohm BNC cables (must be equal length) 7. Two 50-ohm BNC terminations 8. Medium-frequency signal generator |
|--|---|

BEFORE YOU BEGIN, see ADJUSTMENT LOCATIONS in the Diagrams section.

Set-Up

In the indicator mainframe, install the 7D11 and wide-band amplifier unit in the vertical plug-in compartments. Install the time-base unit in the B horizontal plug-in compartment. Set the controls as follows:

TRIGGER	
SLOPE	+
LEVEL	Clockwise
COUPLING	AC
SOURCE	EXT
EVENTS START TRIGGER	
SLOPE	—
LEVEL	Clockwise
B SWEEP DELAY MODE	INDEPENDENT
COUNT MODE	TIME INT CLOCK
FINE DELAY	0.0

✓23. Check Front-Panel Delay Interval Output

- a. Connect the marker output of the time-mark generator to the EXT TRIG IN connector.
- b. Set the time-mark generator for one-microsecond markers
- c. Connect the DLY INTERVAL OUT connector to the amplifier-unit input.
- d. Set the amplifier unit for a calibrated deflection factor of 0.5 volt/division.
- e. Set the mainframe to select the amplifier unit for display and as the internal trigger source for the time-base unit.
- f. Set the time-base unit for auto, internal triggering at the sweep rate of 20 nanosecond/division.
- g. Set the TRIGGER LEVEL control to obtain a display.
- ✓h. CHECK—Displayed pulse amplitude is two divisions or greater (delay interval pulse amplitude is one volt or greater into 50-ohm load).
- ✓i. CHECK—Displayed waveform for 3.5 to four divi-

sions (70 to 80 nanoseconds) between the 50%-amplitude points of the rising and falling portions (DLY INTERVAL OUT signal equal to generated time delay less 20 to 30 nanoseconds).

j. Set the COUNT MODE switch to EVENTS. Connect a 400-millivolt, four-megahertz signal from the medium-frequency signal generator to the EVENTS START TRIG IN connector.

k. Set the DELAY TIME OR EVENTS control for an events-count readout of 0000002.

l. Set the time-base unit for a sweep rate of 200 nanoseconds/division.

m. Set the EVENTS START TRIGGER LEVEL control to obtain a pulse display.

✓n. CHECK—Displayed waveform for 5 divisions between the 50%-amplitude points on the rising and falling portion (DLY INTERVAL OUT signal equal to generated events delay within 30 nanoseconds; one microsecond \pm 30 nanoseconds).

o. Set the amplifier-unit deflection factor to obtain a display amplitude of five or six divisions.

p. Set the time-base unit to start the sweep prior to the rising portion of the waveform at a sweep rate of two nanoseconds/division.

✓q. CHECK—Displayed waveform for not more than 2.5 divisions between the 10%- and 90%-amplitude points (risetime into 50 ohms, five nanoseconds or less).

r. Set the time-base unit to start the sweep prior to the falling portion of the waveform.

Calibration—7D11 Service

✓s. CHECK—Displayed waveform for not more than 2.5 divisions between the 90% and 10%-amplitude points (fall time into 50 ohms, five nanoseconds or less).

24. Check Delay Interval Outputs to Mainframe

a. Set the mainframe for a dual-trace vertical display in the chopped mode.

b. Set the time mark generator for one-microsecond markers.

c. Set the time base unit for auto, internal triggering at a 0.5 microsecond/division sweep rate.

✓d. CHECK—Dual trace display for Pedestal Display fixed near the center of the CRT viewing area and the DLY INTERVAL OUT waveform.

e. Remove the 7D11 from the mainframe (disconnect cables if necessary).

f. Set the Z-Axis Banking switch to the rear. (Enter position see Operating Information section).

g. Install the 7D11 and connect the cables as they were prior to part e of this step.

h. Set the COUNT MODE switch to INT CLOCK.

i. Set the DELAY TIME or EVENTS control for a time interval clock readout of 0.0000 nms.

✓j. CHECK—CRT display is blanked out during the delay interval (blanking occurs during the positive portion of the displayed waveforms).

k. Disconnect all cables.

l. Remove the 7D11 from the mainframe. Set the Z-Axis Banking switch to the forward, unblanked position. Install the 7D11 in the mainframe.

✓25. Check Front-Panel Delayed Trigger Output

a. Set the COUNT MODE switch to TIME INT CLOCK.

b. Connect the marker output of the time mark generator to the EXT TRIG IN connector.

c. Set the time mark generator for one microsecond markers.

d. Connect the DLY'D TRIG OUT connector to the amplifier unit input.

e. Set the mainframe to select the amplifier unit for display and for the internal trigger source.

f. Set the amplifier unit for a calibrated deflection factor of 0.5 volt/division.

✓g. CHECK—Displayed pulse amplitude is two divisions or greater (one volt or greater into 50 ohm load).

h. Set the amplifier unit for a five or six division display. Vertically center the display.

i. Set the time-base unit to trigger prior to the rising portion of the waveform at a sweep rate of 50 nanoseconds/division.

✓j. CHECK—Displayed waveform for four to five divisions between the 50% amplitude points on the rising and falling portion (pulse width, 200 to 250 nanoseconds).

k. Set the time base unit for a sweep rate of two nanoseconds/division.

NOTE

If the measured risetime in the following check is greater than the two-nanosecond limit, the actual signal risetime must be calculated by the formula:

$$T_s = \sqrt{T_m^2 - T_v^2}$$

where T_s = actual signal risetime, T_m = measured risetime, and T_v = vertical system risetime. For example, if the measured risetime is 2.1 nanoseconds and the vertical-system risetime is 0.8 nanoseconds, then the actual signal risetime is

$$T_s = \sqrt{4.41 - 0.64} = \sqrt{3.77} = 1.94 \text{ nanoseconds.}$$

Also, the accuracy of the timebase can be a critical factor in this measurement.

The vertical-system risetime used in this example (0.8 nanoseconds) is the combined risetime of the Tektronix 7904 Oscilloscope and 7A19 Amplifier used for this procedure. Risetimes for other mainframe amplifier combinations are listed in your Tektronix catalog, or may be obtained from your Tektronix Field Office or representative in your area.

✓l. CHECK—Displayed waveform for not more than one division between the 10% and 90%-amplitude points (risetime into 50-ohm load, two nanoseconds or less).

m. Set the time base unit to trigger prior to the falling portion of the waveform at a sweep rate of two nanoseconds/division.

✓n. CHECK—Displayed waveform for not more than 2.5 divisions between the 90% and 10% amplitude points (fall time into 50-ohm load, five nanoseconds or less).

o. Disconnect all test equipment.

√26. Check Delayed Trigger Output to Mainframe

a. Connect the marker output of the time-mark generator to the EXT TRIG IN connector and to the amplifier-unit input.

b. Set the time-mark generator for one-microsecond markers.

c. Set the time-base unit for auto, internal triggering at a 0.5-microsecond/division sweep rate.

d. Set the mainframe to select the 7D11 as the internal trigger source for the time-base unit.

e. Turn the DELAY TIME OR EVENTS control clockwise to obtain a slowly increasing delay-time readout.

√f. CHECK—The displayed markers move toward the left as the delay time increases.

√27. Check Delayed Trigger and Delay Interval Coincidence

a. Disconnect the time-mark generator signal from the amplifier unit. Leave the marker output connected to the 7D11 EXT TRIG IN connector.

b. Replace the wide-band amplifier unit with the dual-trace amplifier unit.

c. Set the DELAY TIME OR EVENTS control for a delay-time readout of 0.0001+ mS.

d. Connect the DLY'D TRIG OUT and the DLY INTERVAL OUT connectors to the amplifier-unit inputs with two equal-length 50-ohm BNC cables and 50-ohm terminations.

e. Set the mainframe to select the amplifier unit as the internal trigger source.

f. Set the amplifier unit for dual-trace operation in the chopped mode. Select the Delay-Interval channel as the internal trigger source. Set the deflection factors for six-division displays. Vertically center both waveforms.

g. Set the time-base unit to trigger on the falling portion of the Delay Interval waveform at a magnified sweep rate of two nanoseconds/division (use a basic sweep rate of 20 nanoseconds/division, magnified 10 times with X10 magnifier or delayed sweep to obtain two nanoseconds/division).

√h. CHECK—Displayed waveforms for not more than one division between the rising portion of the Delayed Trigger pulse and the falling portion of the Delay Interval pulse, as measured at the 50%-amplitude points (rising edge of Delayed Trigger pulse is coincident with falling edge of Delay Interval pulse within two nanoseconds; see Fig. 4-3).

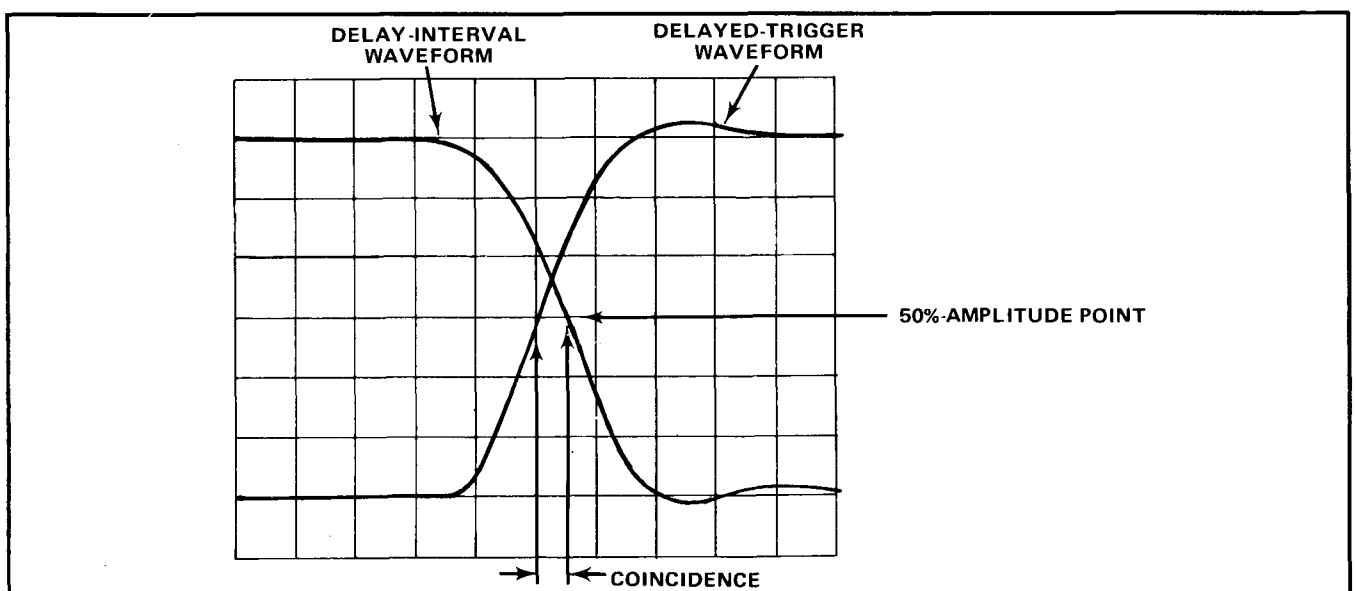

Fig. 4-3. Simulated waveforms showing display used to check Delay Interval and Delayed Trigger coincidence.

Calibration—7D11 Service

√28. Check B Sweep Delay Mode Operation

- a. Install the 7D11 in the A horizontal compartment of the mainframe.
- b. Set the SOURCE switch to INT.
- c. Connect the marker output of the time-mark generator to the amplifier-unit input.
- d. Set the time-mark generator for one- and ten-microsecond markers.
- e. Set the amplifier unit to display the time markers (single-channel operation). Select the displayed channel as the internal trigger source for the time-base unit and for the 7D11.
- f. Set the time-base unit to trigger on the ten-microsecond markers as a sweep rate of two microseconds/division.
- g. Set the DELAY TIME OR EVENTS control for a delay-time readout of 0.0200+ mS.
- h. Set the B SWEEP DELAY MODE switch to B STARTS AFTER DELAY.
- √i. CHECK—Displayed markers for a sweep starting at a point determined by the delay-time interval (it might be necessary to set the TRIGGER LEVEL control for a stable display). Turn the DELAY TIME OR EVENTS control clockwise and counterclockwise and check that the markers move to the left and right respectively.
- j. Set the B SWEEP DELAY MODE switch to B TRIGGERABLE AFTER DELAY.
- √k. CHECK—Displayed markers with the sweep triggered on a ten-microsecond marker.
- l. Disconnect all test equipment and remove the plug-in units from the mainframe.

This completes the Calibration procedure for the 7D11.

REPLACEABLE ELECTRICAL PARTS

PARTS ORDERING INFORMATION

Replacement parts are available from or through your local Tektronix, Inc. Field Office or representative.

Changes to Tektronix instruments are sometimes made to accommodate improved components as they become available, and to give you the benefit of the latest circuit improvements developed in our engineering department. It is therefore important, when ordering parts, to include the following information in your order: Part number, instrument type or number, serial number, and modification number if applicable.

If a part you have ordered has been replaced with a new or improved part, your local Tektronix, Inc. Field Office or representative will contact you concerning any change in part number.

Change information, if any, is located at the rear of this manual.

SPECIAL NOTES AND SYMBOLS

X000 Part first added at this serial number
00X Part removed after this serial number

ITEM NAME

In the Parts List, an Item Name is separated from the description by a colon (:). Because of space limitations, an Item Name may sometimes appear as incomplete. For further Item Name identification, the U.S. Federal Cataloging Handbook H6-1 can be utilized where possible.

ABBREVIATIONS

ACTR	ACTUATOR	PLSTC	PLASTIC
ASSY	ASSEMBLY	QTZ	QUARTZ
CAP	CAPACITOR	RECP	RECEPTACLE
CER	CERAMIC	RES	RESISTOR
CKT	CIRCUIT	RF	RADIO FREQUENCY
COMP	COMPOSITION	SEL	SELECTED
CONN	CONNECTOR	SEMICOND	SEMICONDUCTOR
ELCTLT	ELECTROLYTIC	SENS	SENSITIVE
ELEC	ELECTRICAL	VAR	VARIABLE
INCAND	INCANDESCENT	WW	WIREWOUND
LED	LIGHT EMITTING DIODE	XFMR	TRANSFORMER
NONWIR	NON WIREWOUND	XTAL	CRYSTAL

CROSS INDEX—MFR. CODE NUMBER TO MANUFACTURER

Mfr. Code	Manufacturer	Address	City, State, Zip
00853	SANGAMO ELECTRIC CO., S. CAROLINA DIV.	P O BOX 128	PICKENS, SC 29671
01121	ALLEN-BRADLEY COMPANY	1201 2ND STREET SOUTH	MILWAUKEE, WI 53204
01295	TEXAS INSTRUMENTS, INC., SEMICONDUCTOR GROUP	P O BOX 5012, 13500 N CENTRAL EXPRESSWAY	DALLAS, TX 75222
02111	SPECTROL ELECTRONICS CORPORATION	17070 EAST GALE AVENUE	CITY OF INDUSTRY, CA 91745
02114	FERROXCUBE CORPORATION	PO BOX 359, MARION ROAD	SAUGERTIES, NY 12477
02735	RCA CORPORATION, SOLID STATE DIVISION	ROUTE 202	SOMERVILLE, NY 08876
03508	GENERAL ELECTRIC COMPANY, SEMI-CONDUCTOR PRODUCTS DEPARTMENT	ELECTRONICS PARK	SYRACUSE, NY 13201
04222	AVX CERAMICS, DIVISION OF AVX CORP.	P O BOX 867, 19TH AVE. SOUTH	MURTLE BEACH, SC 29577
04713	MOTOROLA, INC., SEMICONDUCTOR PROD. DIV.	5005 E MCDOWELL RD, PO BOX 20923	PHOENIX, AZ 85036
05091	TRI-ORDINATE CORPORATION	343 SNYDER AVENUE	BERKELEY HEIGHTS, NJ 07922
07263	FAIRCHILD SEMICONDUCTOR, A DIV. OF FAIRCHILD CAMERA AND INSTRUMENT CORP.	464 ELLIS STREET	MOUNTAIN VIEW, CA 94042
07910	TELEDYNE SEMICONDUCTOR	12515 CHADRON AVE.	HAWTHORNE, CA 90250
08806	GENERAL ELECTRIC CO., MINIATURE LAMP PRODUCTS DEPARTMENT	NELA PARK	CLEVELAND, OH 44112
13571	ELECTRONIC RESEARCH CO.	P O BOX 913	SHAWNEE MISSION, KS 66201
22526	BERG ELECTRONICS, INC.	YOUK EXPRESSWAY	NEW CUMBERLAND, PA 17070
27014	NATIONAL SEMICONDUCTOR CORP.	2900 SEMICONDUCTOR DR.	SANTA CLARA, CA 95051
28480	HEWLETT-PACKARD CO., CORPORATE HQ.	1501 PAGE MILL RD.	PALO ALTO, CA 94304
32997	BOURNS, INC., TRIMPOT PRODUCTS DIV.	1200 COLUMBIA AVE.	RIVERSIDE, CA 92507
56289	SPRAGUE ELECTRIC CO.		NORTH ADAMS, MA 01247
71400	BUSSMAN MFG., DIVISION OF MCGRAW-EDISON CO.	2536 W. UNIVERSITY ST.	ST. LOUIS, MO 63107
71590	CENTRALAB ELECTRONICS, DIV. OF GLOBE-UNION, INC.	P O BOX 858	FORT DODGE, IA 50501
72982	ERIE TECHNOLOGICAL PRODUCTS, INC.	644 W. 12TH ST.	ERIE, PA 16512
75042	TRW ELECTRONIC COMPONENTS, IRC FIXED RESISTORS, PHILADELPHIA DIVISION	401 N. BROAD ST.	PHILADELPHIA, PA 19108
78488	STACKPOLE CARBON CO.		ST. MARYS, PA 15857
79727	C-W INDUSTRIES	550 DAVISVILLE RD., P O BOX 96	WARMINISTER, PA 18974
80009	TEKTRONIX, INC.	P O BOX 500	BEAVERTON, OR 97077
80740	BECKMAN INSTRUMENTS, INC.	2500 HARBOR BLVD.	FULLERTON, CA 92634
81073	GRAYHILL, INC.	561 HILLGROVE AVE., PO BOX 373	LA GRANGE, IL 60525
81483	INTERNATIONAL RECTIFIER CORP.	9220 SUNSET BLVD.	LOS ANGELES, CA 90069
90201	MALLORY CAPACITOR CO., DIV. OF P. R. MALLORY AND CO., INC.	3029 E WASHINGTON STREET	INDIANAPOLIS, IN 46206
91637	DALE ELECTRONICS, INC.	P O BOX 372	COLUMBUS, NE 68601
93958	REPUBLIC ELECTRONICS CORPORATION	P. O. BOX 609	PATERSON, NJ 07524
		176 E 7TH STREET	

Ckt No.	Tektronix Part No.	Serial/Model No. Eff	Dscont	Name & Description	Mfr Code	Mfr Part Number
A1	670-1221-02			CKT BOARD ASSY:--SOURCE SWITCH	80009	670-1221-02
A2	670-1222-02			CKT BOARD ASSY:--COUPLING SWITCH	80009	670-1222-02
A3	670-2156-00			CKT BOARD ASSY:--TRIGGER	80009	670-2156-00
A4	670-2150-00	B010100	B019999	CKT BOARD ASSY:--INTERFACE	80009	670-2150-00
A4	670-2150-01	B020000	B029999	CKT BOARD ASSY:--INTERFACE	80009	670-2150-01
A4	670-2150-02	B030000	B089999	CKT BOARD ASSY:--INTERFACE	80009	670-2150-02
A4	670-2150-04	B090000	B099999	CKT BOARD ASSY:--INTERFACE	80009	670-2150-04
A4	670-2150-07	B100000		CKT BOARD ASSY:--INTERFACE	80009	670-2150-07
A5	670-2152-00			CKT BOARD ASSY:--RF	80009	670-2152-00
A6	670-2149-00			CKT BOARD ASSY:--COUNT MODE SWITCH	80009	670-2149-00
A7	670-2151-00	B010100	B019999	CKT BOARD ASSY:--LOGIC	80009	670-2151-00
A7	670-2151-01	B020000	B029999	CKT BOARD ASSY:--LOGIC	80009	670-2151-01
A7	670-2151-02	B030000		CKT BOARD ASSY:--LOGIC	80009	670-2151-02
A8	670-2148-00			CKT BOARD ASSY:--B SWEEP DELAY MODE SWITCH	80009	670-2148-00
C2	283-0239-00			CAP.,FXD,CER DI:0.022UF,10%,50V	72982	8131N075C223K
C5	281-0123-00			CAP.,VAR,CER DI:5-25PF,100V	72982	518-000A5-25
C6	281-0661-00			CAP.,FXD,CER DI:0.8PF,+/-0.1PF,500V	72982	301-000C0K0808B
C10	281-0123-00			CAP.,VAR,CER DI:5-25PF,100V	72982	518-000A5-25
C13	281-0632-00			CAP.,FXD,CER DI:35PF,1%,500V	72982	308-000C0G0350F
C21	283-0080-00			CAP.,FXD,CER DI:0.022UF,+80-20%,25V	56289	19C611
C24	281-0122-00			CAP.,VAR,CER DI:2.5-9PF,100V	72982	518-000A2.5-9
C32	283-0000-00			CAP.,FXD,CER DI:0.001UF,+100-0%,500V	72982	831-516E102P
C38	283-0000-00			CAP.,FXD,CER DI:0.001UF,+100-0%,500V	72982	831-516E102P
C39	281-0613-00			CAP.,FXD,CER DI:10PF,+/-1PF,200V	72982	374-001C0G0100F
C41	290-0523-00			CAP.,FXD,ELCTLT:2.2UF,20%,20V	56289	196D225X0020HA1
C52	283-0178-00			CAP.,FXD,CER DI:0.1UF,+80-20%,100V	72982	8131N145 E 104Z
C62	281-0511-00			CAP.,FXD,CER DI:22PF,+/-2.2PF,500V	72982	301-000C0G0220K
C67	281-0511-00			CAP.,FXD,CER DI:22PF,+/-2.2PF,500V	72982	301-000C0G0220K
C75	283-0080-00			CAP.,FXD,CER DI:0.022UF,+80-20%,25V	56289	19C611
C82	283-0080-00			CAP.,FXD,CER DI:0.022UF,+80-20%,25V	56289	19C611
C83	283-0169-00			CAP.,FXD,CER DI:0.022UF,10%,200V	72982	8131N225X5R0223K
C84	283-0080-00			CAP.,FXD,CER DI:0.022UF,+80-20%,25V	56289	19C611
C86	283-0080-00			CAP.,FXD,CER DI:0.022UF,+80-20%,25V	56289	19C611
C87	283-0194-00			CAP.,FXD,CER DI:4.7UF,20%,50V	72982	8151N080651475M
C88	283-0051-00			CAP.,FXD,CER DI:0.0033UF,5%,100V	72982	8131N145 A 332J
C96	283-0068-00			CAP.,FXD,CER DI:0.01UF,+100-0%,500V	56289	19C241
C102	283-0633-00			CAP.,FXD,MICA D:77PF,1%,100V	00853	D151E770F0
C106	283-0212-00			CAP.,FXD,CER DI:2UF,20%,50V	72982	8141N064Z5U0205M
C119	281-0516-00			CAP.,FXD,CER DI:39PF,+/-3.9PF,500V	72982	301-000U2J0390K
C122	283-0080-00			CAP.,FXD,CER DI:0.022UF,+80-20%,25V	56289	19C611
C126	283-0080-00			CAP.,FXD,CER DI:0.022UF,+80-20%,25V	56289	19C611
C137	290-0523-00			CAP.,FXD,ELCTLT:2.2UF,20%,20V	56289	196D225X0020HA1
C145	281-0513-00			CAP.,FXD,CER DI:27PF,+/-5.4PF,500V	72982	301-000P2G0270M
C150	290-0246-00			CAP.,FXD,ELCTLT:3.3UF,10%,15V	56289	162D335X9015CD2
C160	290-0136-00			CAP.,FXD,ELCTLT:2.2UF,20%,20V	56289	162D225X0020CD2
C162	281-0613-00			CAP.,FXD,CER DI:10PF,+/-1PF,200V	72982	374-001C0G0100F
C166	281-0513-00			CAP.,FXD,CER DI:27PF,+/-5.4PF,500V	72982	301-000P2G0270M
C174	281-0651-00	XB040000		CAP.,FXD,CER DI:47PF,5%,200V	72982	374-001T2H0470J
C177	290-0523-00			CAP.,FXD,ELCTLT:2.2UF,20%,20V	56289	196D225X0020HA1
C179	283-0178-00	XB030000		CAP.,FXD,CER DI:0.1UF,+80-20%,100V	72982	8131N145 E 104Z
C182	281-0518-00			CAP.,FXD,CER DI:47PF,+/-9.4PF,500V	72982	301-000U2J0470M
C185	290-0187-00			CAP.,FXD,ELCTLT:4.7UF,20%,35V	56289	150D475X0035B2
C188	290-0267-00			CAP.,FXD,ELCTLT:1UF,20%,35V	56289	162D105X0035CD2
C200	290-0523-00			CAP.,FXD,ELCTLT:2.2UF,20%,20V	56289	196D225X0020HA1

Replaceable Electrical Parts—7D11

Ckt No.	Tektronix Part No.	Serial/Model No. Eff	Dscont	Name & Description	Mfr Code	Mfr Part Number
C220	283-0001-00			CAP., FXD, CER DI:0.005UF, +100-0%, 500V	72982	831-559E502P
C230	283-0178-00			CAP., FXD, CER DI:0.1UF, +80-20%, 100V	72982	8131N145 E 104Z
C240	281-0670-00			CAP., FXD, CER DI:1.8PF, +/-0.1PF, 500V	72982	374-005COK0189B
C241	290-0527-00			CAP., FXD, ELCTLT:15UF, 20%, 20V	90201	TDC156M020FL
C242	281-0562-00			CAP., FXD, CER DI:39PF, 10%, 500V	72982	301-000U2J0390K
C244	285-0699-00			CAP., FXD, PLSTC:0.0047UF, 10%, 100V	56289	610P110
C253	283-0222-00			CAP., FXD, CER DI:120PF, 20%, 50V	93958	51720-1
C255	290-0527-00			CAP., FXD, ELCTLT:15UF, 20%, 20V	90201	TDC156M020FL
C256	283-0122-00			CAP., FXD, CER DI:270PF, 5%, 500V	72982	861-005Z5P0271J
C258	281-0151-00			CAP., VAR, CER DI:1-3UF, 100V	72982	518-600A1-3
C259	281-0615-00			CAP., FXD, CER DI:3.9PF, +/-0.5PF, 200V	72982	374-001C0J0399D
C260	281-0618-00	B010100	B029999	CAP., FXD, CER DI:4.7PF, +/-0.5PF, 200V	72982	374-001C0H0479D
C260	281-0717-00	B030000		CAP., FXD, CER DI:7.8PF, +/-0.1PF, 500V	72982	374-005COG789F
C262	281-0651-00			CAP., FXD, CER DI:47PF, 5%, 200V	72982	374-001T2H0470J
C266	281-0656-00			CAP., FXD, CER DI:22PF, 5%, 500V	72982	374-000C0G0220J
C276	281-0651-00			CAP., FXD, CER DI:47PF, 5%, 200V	72982	374-001T2H0470J
C279	281-0651-00			CAP., FXD, CER DI:47PF, 5%, 200V	72982	374-001T2H0470J
C281	283-0047-00			CAP., FXD, CER DI:270PF, 5%, 500V	72982	861-518B271J
C322	283-0000-00			CAP., FXD, CER DI:0.001UF, +100-0%, 500V	72982	831-516E102P
C339	290-0523-00			CAP., FXD, ELCTLT:2.2UF, 20%, 20V	56289	196D225X0020HA1
C351	283-0197-00	XB100000		CAP., FXD, CER DI:470PF, 5%, 100V	72982	8121N075C0G0471J
C353	281-0523-00			CAP., FXD, CER DI:100PF, +/-20PF, 500V	72982	301-000U2M0101M
C358	283-0669-00			CAP., FXD, MICA D:360PF, 1%, 500V	00853	D155F361F0
C364	283-0178-00	XB030000		CAP., FXD, CER DI:0.1UF, +80-20%, 100V	72982	8131N145 E 104Z
C366	281-0656-00			CAP., FXD, CER DI:22PF, 5%, 500V	72982	374-000C0G0220J
C369	281-0651-00			CAP., FXD, CER DI:47PF, 5%, 200V	72982	374-001T2H0470J
C372	281-0618-00			CAP., FXD, CER DI:4.7PF, +/-0.5PF, 200V	72982	374-001C0H0479D
C374	283-0080-00			CAP., FXD, CER DI:0.022UF, +80-20%, 25V	56289	19C611
C385	281-0656-00			CAP., FXD, CER DI:22PF, 5%, 500V	72982	374-000C0G0220J
C390	281-0651-00			CAP., FXD, CER DI:47PF, 5%, 200V	72982	374-001T2H0470J
C393	281-0700-00			CAP., FXD, CER DI:3.3PF, 10%, 200V	72982	374-001S3B0339K
C395	283-0047-00			CAP., FXD, CER DI:270PF, 5%, 500V	72982	861-518B271J
C438	283-0000-00			CAP., FXD, CER DI:0.001UF, +100-0%, 500V	72982	831-516E102P
C507	290-0530-00	B010100	B019999	CAP., FXD, ELCTLT:68UF, 20%, 6V	90201	TDC686M006NLF
C507	283-0178-00	B020000		CAP., FXD, CER DI:0.1UF, +80-20%, 100V	72982	8131N145 E 104Z
C510	290-0530-00	XB020000		CAP., FXD, ELCTLT:68UF, 20%, 6V	90201	TDC686M006NLF
C517	290-0530-00	B010100	B019999	CAP., FXD, ELCTLT:68UF, 20%, 6V	90201	TDC686M006NLF
C517	283-0178-00	B020000		CAP., FXD, CER DI:0.1UF, +80-20%, 100V	72982	8131N145 E 104Z
C524	283-0178-00			CAP., FXD, CER DI:0.1UF, +80-20%, 100V	72982	8131N145 E 104Z
C528	290-0523-00			CAP., FXD, ELCTLT:2.2UF, 20%, 20V	56289	196D225X0020HA1
C534	281-0523-00			CAP., FXD, CER DI:100PF, +/-20PF, 500V	72982	301-000U2M0101M
C535	283-0028-00	B010100	B029999	CAP., FXD, CER DI:0.0022UF, 20%, 50V	56289	19C606
C535	283-0067-00	B030000		CAP., FXD, CER DI:0.001UF, 10%, 200V	72982	835-515B102K
C540	283-0028-00	B010100	B029999X	CAP., FXD, CER DI:0.0022UF, 20%, 50V	56289	19C606
C560	281-0650-00			CAP., FXD, CER DI:18PF, 10%, 200V	72982	374-001C0H0180K
C563	281-0638-00			CAP., FXD, CER DI:240PF, 5%, 500V	72982	301000Z5D241J
C568	283-0178-00			CAP., FXD, CER DI:0.1UF, +80-20%, 100V	72982	8131N145 E 104Z
C569	281-0540-00			CAP., FXD, CER DI:51PF, 5%, 500V	72982	301-000U2J0510J
C581	281-0543-00	B010100	B019999	CAP., FXD, CER DI:270PF, 10%, 500V	72982	301055X5P271K
C581	281-0525-00	B020000		CAP., FXD, CER DI:470PF, +/-94PF, 500V	04222	7001-1364
C583	283-0204-00	XB020000		CAP., FXD, CER DI:0.01UF, 20%, 50V	72982	8121N075Z5U0103M
C584	283-0239-00	B010100	B019999	CAP., FXD, CER DI:0.022UF, 10%, 50V	72982	8131N075C223K
C584	283-0204-00	B020000		CAP., FXD, CER DI:0.01UF, 20%, 50V	72982	8121N075Z5U0103M
C586	281-0525-00			CAP., FXD, CER DI:470PF, +/-94PF, 500V	04222	7001-1364

Ckt No.	Tektronix Part No.	Serial/Model No. Eff	Dscont	Name & Description	Mfr Code	Mfr Part Number
C589	281-0123-00			CAP., VAR, CER DI:5-25PF, 100V	72982	518-000A5-25
C591	283-0635-00			CAP., FXD, MICA D:51PF, 1%, 100V	00853	D151E510F0
C593	281-0543-00	B010100	B029999X	CAP., FXD, CER DI:270PF, 10%, 500V	72982	301055X5P271K
C596	283-0212-00	B010100	B029999	CAP., FXD, CER DI:2UF, 20%, 50V	72982	8141N064Z5U0205M
C596	281-0580-00	B030000		CAP., FXD, CER DI:470PF, 10%, 500V	04222	7001-1374
C598	281-0123-00			CAP., VAR, CER DI:5-25PF, 100V	72982	518-000A5-25
C601	281-0523-00			CAP., FXD, CER DI:100PF, +/-20PF, 500V	72982	301-000U2M0101M
C604	290-0523-00			CAP., FXD, ELCTLT:2.2UF, 20%, 20V	56289	196D225X0020HA1
C607	290-0523-00			CAP., FXD, ELCTLT:2.2UF, 20%, 20V	56289	196D225X0020HA1
C610	283-0178-00			CAP., FXD, CER DI:0.1UF, +80-20%, 100V	72982	8131N145 E 104Z
C618	283-0000-00	B010100	B039999X	CAP., FXD, CER DI:0.001UF, +100-0%, 500V	72982	831-516E102P
C622	283-0178-00			CAP., FXD, CER DI:0.1UF, +80-20%, 100V	72982	8131N145 E 104Z
C626	290-0523-00			CAP., FXD, ELCTLT:2.2UF, 20%, 20V	56289	196D225X0020HA1
C627	281-0592-00	XB050000		CAP., FXD, CER DI:4.7PF, +/-0.5PF, 500V	72982	301-023COH0479D
C639	281-0651-00	XB020000		CAP., FXD, CER DI:47PF, 5%, 200V	72982	374-001T2H0470J
C656	281-0540-00			CAP., FXD, CER DI:51PF, 5%, 500V	72982	301-000U2J0510J
C668	281-0504-00			CAP., FXD, CER DI:10PF, +/-1PF, 500V	72982	301-055COG0100F
C725	285-0862-00			CAP., FXD, PLSTC:0.001, 10%, 100V	56289	410P10291
C736	281-0589-00			CAP., FXD, CER DI:170PF, 5%, 500V	72982	301000Z5D171J
C751	290-0526-00			CAP., FXD, ELCTLT:6.8UF, 20%, 6V	90201	TDC685M006EL
C755	283-0000-00	B010100	B029999	CAP., FXD, CER DI:0.001UF, +100-0%, 500V	72982	831-516E102P
C755	283-0067-00	B030000		CAP., FXD, CER DI:0.001UF, 10%, 200V	72982	835-515B102K
C838	283-0076-00			CAP., FXD, CER DI:27PF, 10%, 500V	56289	40C287A2
C943	281-0525-00	B010100	B029999	CAP., FXD, CER DI:470PF, +/-94PF, 500V	04222	7001-1364
C943	283-0028-00	B030000		CAP., FXD, CER DI:0.0022UF, 20%, 50V	56289	19C606
C968	281-0543-00			CAP., FXD, CER DI:270PF, 10%, 500V	72982	301055X5P271K
C1001	283-0178-00			CAP., FXD, CER DI:0.1UF, +80-20%, 100V	72982	8131N145 E 104Z
C1002	290-0527-00			CAP., FXD, ELCTLT:15UF, 20%, 20V	90201	TDC156M020FL
C1004	283-0178-00			CAP., FXD, CER DI:0.1UF, +80-20%, 100V	72982	8131N145 E 104Z
C1005	290-0527-00			CAP., FXD, ELCTLT:15UF, 20%, 20V	90201	TDC156M020FL
C1007	283-0178-00			CAP., FXD, CER DI:0.1UF, +80-20%, 100V	72982	8131N145 E 104Z
C1008	290-0530-00			CAP., FXD, ELCTLT:68UF, 20%, 6V	90201	TDC686M006NLF
C1009	283-0239-00			CAP., FXD, CER DI:0.022UF, 10%, 50V	72982	8131N075C223K
C1011	290-0535-00			CAP., FXD, ELCTLT:33UF, 20%, 10V	56289	196D336X0010KA1
C1013	290-0523-00			CAP., FXD, ELCTLT:2.2UF, 20%, 20V	56289	196D225X0020HA1
C1015	290-0535-00			CAP., FXD, ELCTLT:33UF, 20%, 10V	56289	196D336X0010KA1
C1018	283-0178-00			CAP., FXD, CER DI:0.1UF, +80-20%, 100V	72982	8131N145 E 104Z
C1019	283-0178-00			CAP., FXD, CER DI:0.1UF, +80-20%, 100V	72982	8131N145 E 104Z
C1020	290-0519-00			CAP., FXD, ELCTLT:100UF, 20%, 20V	56289	196D107X0020MA3
C1021	283-0178-00			CAP., FXD, CER DI:0.1UF, +80-20%, 100V	72982	8131N145 E 104Z
C1033	290-0523-00			CAP., FXD, ELCTLT:2.2UF, 20%, 20V	56289	196D225X0020HA1
C1038	290-0531-00			CAP., FXD, ELCTLT:100UF, 20%, 10V	90201	TDC107M010WLC
C1039	290-0530-00			CAP., FXD, ELCTLT:68UF, 20%, 6V	90201	TDC686M006NLF
C1041	290-0523-00			CAP., FXD, ELCTLT:2.2UF, 20%, 20V	56289	196D225X0020HA1
C1043	283-0080-00			CAP., FXD, CER DI:0.022UF, +80-20%, 25V	56289	19C611
C1045	290-0527-00			CAP., FXD, ELCTLT:15UF, 20%, 20V	90201	TDC156M020FL
C1048	290-0527-00			CAP., FXD, ELCTLT:15UF, 20%, 20V	90201	TDC156M020FL
C1050	283-0080-00			CAP., FXD, CER DI:0.022UF, +80-20%, 25V	56289	19C611
C1051	283-0080-00			CAP., FXD, CER DI:0.022UF, +80-20%, 25V	56289	19C611
C1053	283-0080-00			CAP., FXD, CER DI:0.022UF, +80-20%, 25V	56289	19C611
C1056	290-0523-00			CAP., FXD, ELCTLT:2.2UF, 20%, 20V	56289	196D225X0020HA1
C1058	290-0535-00			CAP., FXD, ELCTLT:33UF, 20%, 10V	56289	196D336X0010KA1
C1061	290-0535-00			CAP., FXD, ELCTLT:33UF, 20%, 10V	56289	196D336X0010KA1

Replaceable Electrical Parts—7D11

Ckt No.	Tektronix Part No.	Serial/Model No. Eff	Dscont	Name & Description	Mfr Code	Mfr Part Number
C1066	290-0532-00			CAP., FXD, ELCTLT:150UF, 20%, 6V	90201	TDC157M006WLC
C1067	283-0178-00			CAP., FXD, CER DI:0.1UF, +80-20%, 100V	72982	8131N145 E 104Z
C1069	283-0080-00			CAP., FXD, CER DI:0.022UF, +80-20%, 25V	56289	19C611
C1072	283-0178-00	XB030000		CAP., FXD, CER DI:0.1UF, +80-20%, 100V	72982	8131N145 E 104Z
C1074	283-0178-00			CAP., FXD, CER DI:0.1UF, +80-20%, 100V	72982	8131N145 E 104Z
C1076	283-0178-00			CAP., FXD, CER DI:0.1UF, +80-20%, 100V	72982	8131N145 E 104Z
CR21	152-0141-02				SEMICONV DEVICE:SILICON, 30V, 150MA	07910
CR27	152-0141-02			SEMICONV DEVICE:SILICON, 30V, 150MA	07910	1N4152
CR28	152-0141-02			SEMICONV DEVICE:SILICON, 30V, 150MA	07910	1N4152
CR122	152-0141-02			SEMICONV DEVICE:SILICON, 30V, 150MA	07910	1N4152
CR126	152-0141-02			SEMICONV DEVICE:SILICON, 30V, 150MA	07910	1N4152
CR128	152-0141-02			SEMICONV DEVICE:SILICON, 30V, 150MA	07910	1N4152
CR129	152-0141-02			SEMICONV DEVICE:SILICON, 30V, 150MA	07910	1N4152
CR141	152-0140-01			SEMICONV DEVICE:TUNNEL, 8PF, 10MA	03508	SMTD905
CR153	152-0141-02			SEMICONV DEVICE:SILICON, 30V, 150MA	07910	1N4152
CR169	152-0140-01			SEMICONV DEVICE:TUNNEL, 8PF, 10MA	03508	SMTD905
CR171	152-0140-01			SEMICONV DEVICE:TUNNEL, 8PF, 10MA	03508	SMTD905
CR184	152-0141-02			SEMICONV DEVICE:SILICON, 30V, 150MA	07910	1N4152
CR222	152-0141-02			SEMICONV DEVICE:SILICON, 30V, 150MA	07910	1N4152
CR223	152-0141-02			SEMICONV DEVICE:SILICON, 30V, 150MA	07910	1N4152
CR248	152-0141-02			SEMICONV DEVICE:SILICON, 30V, 150MA	07910	1N4152
CR252	152-0272-00			SEMICONV DEVICE:SILICON, VV, 6.8 PF	04713	MV1864D
CR271	152-0125-00			SEMICONV DEVICE:TUNNEL, 15PF, 4.7MA	80009	152-0125-00
CR354	152-0153-00			SEMICONV DEVICE:SILICON, 15V, 50MA	80009	152-0153-00
CR362	152-0141-02			SEMICONV DEVICE:SILICON, 30V, 150MA	07910	1N4152
CR364	152-0153-00			SEMICONV DEVICE:SILICON, 15V, 50MA	80009	152-0153-00
CR369	152-0141-02			SEMICONV DEVICE:SILICON, 30V, 150MA	07910	1N4152
CR370	152-0125-00			SEMICONV DEVICE:TUNNEL, 15PF, 4.7MA	80009	152-0125-00
CR386	152-0125-00			SEMICONV DEVICE:TUNNEL, 15PF, 4.7MA	80009	152-0125-00
CR398	152-0141-02			SEMICONV DEVICE:SILICON, 30V, 150MA	07910	1N4152
CR521	152-0141-02			SEMICONV DEVICE:SILICON, 30V, 150MA	07910	1N4152
CR525	152-0141-02			SEMICONV DEVICE:SILICON, 30V, 150MA	07910	1N4152
CR526	152-0141-02			SEMICONV DEVICE:SILICON, 30V, 150MA	07910	1N4152
CR532	152-0141-02			SEMICONV DEVICE:SILICON, 30V, 150MA	07910	1N4152
CR563	152-0141-02			SEMICONV DEVICE:SILICON, 30V, 150MA	07910	1N4152
CR570	152-0141-02			SEMICONV DEVICE:SILICON, 30V, 150MA	07910	1N4152
CR571	152-0141-02			SEMICONV DEVICE:SILICON, 30V, 150MA	07910	1N4152
CR586	152-0141-02	XB030000		SEMICONV DEVICE:SILICON, 30V, 150MA	07910	1N4152
CR605	152-0141-02			SEMICONV DEVICE:SILICON, 30V, 150MA	07910	1N4152
CR609	152-0141-02			SEMICONV DEVICE:SILICON, 30V, 150MA	07910	1N4152
CR632	152-0141-02			SEMICONV DEVICE:SILICON, 30V, 150MA	07910	1N4152
CR633	152-0141-02	XB080000		SEMICONV DEVICE:SILICON, 30V, 150MA	07910	1N4152
CR635	152-0141-02			SEMICONV DEVICE:SILICON, 30V, 150MA	07910	1N4152
CR636	152-0141-02			SEMICONV DEVICE:SILICON, 30V, 150MA	07910	1N4152
CR638	152-0153-00		XB020000		SEMICONV DEVICE:SILICON, 15V, 50MA	80009
CR639	152-0153-00			SEMICONV DEVICE:SILICON, 15V, 50MA	80009	152-0153-00
CR643	152-0153-00			SEMICONV DEVICE:SILICON, 15V, 50MA	80009	152-0153-00
CR644	152-0153-00			SEMICONV DEVICE:SILICON, 15V, 50MA	80009	152-0153-00
CR645	152-0153-00			SEMICONV DEVICE:SILICON, 15V, 50MA	80009	152-0153-00
CR647	152-0153-00			SEMICONV DEVICE:SILICON, 15V, 50MA	80009	152-0153-00
CR655	152-0141-02			SEMICONV DEVICE:SILICON, 30V, 150MA	07910	1N4152
CR656	152-0141-02			SEMICONV DEVICE:SILICON, 30V, 150MA	07910	1N4152

Ckt No.	Tektronix Part No.	Serial/Model No. Eff	Dscont	Name & Description	Mfr Code	Mfr Part Number
CR661	152-0153-00			SEMICON D DEVICE:SILICON,15V,50MA	80009	152-0153-00
CR712	152-0141-02			SEMICON D DEVICE:SILICON,30V,150MA	07910	1N4152
CR715	152-0141-02			SEMICON D DEVICE:SILICON,30V,150MA	07910	1N4152
CR718	152-0008-00			SEMICON D DEVICE:GERMANIUM,75V,60MA	80009	152-0008-00
CR729	152-0141-02			SEMICON D DEVICE:SILICON,30V,150MA	07910	1N4152
CR735	152-0141-02			SEMICON D DEVICE:SILICON,30V,150MA	07910	1N4152
CR798	152-0322-00			SEMICON D DEVICE:SILICON,15V,HOT CARRIER	28480	5082-2672
CR830	152-0141-02			SEMICON D DEVICE:SILICON,30V,150MA	07910	1N4152
CR832	152-0141-02			SEMICON D DEVICE:SILICON,30V,150MA	07910	1N4152
CR834	152-0141-02			SEMICON D DEVICE:SILICON,30V,150MA	07910	1N4152
CR930	152-0141-02			SEMICON D DEVICE:SILICON,30V,150MA	07910	1N4152
CR932	152-0141-02			SEMICON D DEVICE:SILICON,30V,150MA	07910	1N4152
CR934	152-0141-02			SEMICON D DEVICE:SILICON,30V,150MA	07910	1N4152
CR936	152-0141-02			SEMICON D DEVICE:SILICON,30V,150MA	07910	1N4152
CR953	152-0141-02			SEMICON D DEVICE:SILICON,30V,150MA	07910	1N4152
CR954	152-0141-02			SEMICON D DEVICE:SILICON,30V,150MA	07910	1N4152
CR955	152-0141-02			SEMICON D DEVICE:SILICON,30V,150MA	07910	1N4152
CR960	152-0141-02			SEMICON D DEVICE:SILICON,30V,150MA	07910	1N4152
CR961	152-0141-02			SEMICON D DEVICE:SILICON,30V,150MA	07910	1N4152
CR962	152-0141-02			SEMICON D DEVICE:SILICON,30V,150MA	07910	1N4152
CR963	152-0141-02			SEMICON D DEVICE:SILICON,30V,150MA	07910	1N4152
CR965	152-0141-02			SEMICON D DEVICE:SILICON,30V,150MA	07910	1N4152
CR967	152-0141-02			SEMICON D DEVICE:SILICON,30V,150MA	07910	1N4152
CR971	152-0141-02			SEMICON D DEVICE:SILICON,30V,150MA	07910	1N4152
CR972	152-0141-02			SEMICON D DEVICE:SILICON,30V,150MA	07910	1N4152
CR973	152-0141-02			SEMICON D DEVICE:SILICON,30V,150MA	07910	1N4152
CR974	152-0141-02			SEMICON D DEVICE:SILICON,30V,150MA	07910	1N4152
CR975	152-0141-02			SEMICON D DEVICE:SILICON,30V,150MA	07910	1N4152
CR976	152-0141-02			SEMICON D DEVICE:SILICON,30V,150MA	07910	1N4152
CR977	152-0141-02			SEMICON D DEVICE:SILICON,30V,150MA	07910	1N4152
CR978	152-0141-02			SEMICON D DEVICE:SILICON,30V,150MA	07910	1N4152
CR979	152-0141-02			SEMICON D DEVICE:SILICON,30V,150MA	07910	1N4152
CR980	152-0141-02			SEMICON D DEVICE:SILICON,30V,150MA	07910	1N4152
CR981	152-0141-02			SEMICON D DEVICE:SILICON,30V,150MA	07910	1N4152
CR990	152-0141-02			SEMICON D DEVICE:SILICON,30V,150MA	07910	1N4152
CR993	152-0141-02			SEMICON D DEVICE:SILICON,30V,150MA	07910	1N4152
CR995	152-0141-02			SEMICON D DEVICE:SILICON,30V,150MA	07910	1N4152
CR998	152-0141-02			SEMICON D DEVICE:SILICON,30V,150MA	07910	1N4152
CR1066	152-0066-00			SEMICON D DEVICE:SILICON,400V,750MA	80009	152-0066-00
DS197	150-0048-00			LAMP, INCAND:5V,60MA	08806	683
F1020	159-0022-00			FUSE, CARTRIDGE:3AG,1A,250V,FAST-BLOW	71400	AGC 1
J12	131-0955-00			CONNECTOR, RCPT, :BNC,FEMALE,W/HARDWARE	05091	31-279
J210	131-0955-00			CONNECTOR, RCPT, :BNC,FEMALE,W/HARDWARE	05091	31-279
J573	131-1003-00			CONNECTOR BODY, :CKT CD MT,3 PRONG	80009	131-1003-00
J575	131-0955-00			CONNECTOR, RCPT, :BNC,FEMALE,W/HARDWARE	05091	31-279
J657	131-1003-00			CONNECTOR BODY, :CKT CD MT,3 PRONG	80009	131-1003-00
J659	131-0955-00			CONNECTOR, RCPT, :BNC,FEMALE,W/HARDWARE	05091	31-279
L106	276-0507-00			SHIELDING BEAD, :0.6UH	78488	57-0180-7D 500B
L130	276-0507-00			SHIELDING BEAD, :0.6UH	78488	57-0180-7D 500B
L141	108-0420-00			COIL, RF:60NH	80009	108-0420-00
L175	276-0532-00	XB040000		SHIELDING BEAD, :	02114	56-590-65/4A6

Replaceable Electrical Parts—7D11

Ckt No.	Tektronix Part No.	Serial/Model No. Eff	Dscont	Name & Description	Mfr Code	Mfr Part Number
L244	108-0395-00			COIL, RF: 64UH	80009	108-0395-00
L253 ¹						
L260	276-0507-00	B010100	B029999X	SHIELDING BEAD, :0.6UH	78488	57-0180-7D 500B
L271	108-0707-00			COIL, RF: 15ONH	80009	108-0707-00
L339	276-0507-00			SHIELDING BEAD, :0.6UH	78488	57-0180-7D 500B
L378	108-0707-00			COIL, RF: 15ONH	80009	108-0707-00
L569	276-0507-00			SHIELDING BEAD, :0.6UH	78488	57-0180-7D 500B
L574	276-0525-00			CORE, FERRITE: 0.196 ID X 0.437"OD	01121	T037C351A
L658	276-0525-00			CORE, FERRITE: 0.196 ID X 0.437"OD	01121	T037C351A
L968	276-0507-00			SHIELDING BEAD, :0.6UH	78488	57-0180-7D 500B
L1020	120-0638-00			XFMR, TOROID: 15 TURNS, BIFILAR	80009	120-0638-00
L1039	120-0638-00			XFMR, TOROID: 15 TURNS, BIFILAR	80009	120-0638-00
LR265	108-0468-00			COIL, RF: 0.11UH	80009	108-0468-00
LR380	108-0468-00			COIL, RF: 0.11UH	80009	108-0468-00
LR383	108-0468-00			COIL, RF: 0.11UH	80009	108-0468-00
LR1001	108-0537-00			COIL, RF: 200UH	80009	108-0537-00
LR1004	108-0537-00			COIL, RF: 200UH	80009	108-0537-00
LR1007	108-0537-00			COIL, RF: 200UH	80009	108-0537-00
LR1048	108-0537-00			COIL, RF: 200UH	80009	108-0537-00
LR1056	108-0537-00			COIL, RF: 200UH	80009	108-0537-00
P754	131-0608-00	XB030000		CONTACT, ELEC: 0.365 INCH LONG	22526	47357
Q32A, B	151-1011-00			TRANSISTOR: SILICON, JFE, N-CHANNEL, DUAL	80009	151-1011-00
Q37	151-0221-00			TRANSISTOR: SILICON, PNP	80009	151-0221-00
Q41	151-0367-00			TRANSISTOR: SILICON, NPN, SEL FROM 3571TP	80009	151-0367-00
Q71	151-0221-00			TRANSISTOR: SILICON, PNP	80009	151-0221-00
Q75	151-0367-00			TRANSISTOR: SILICON, NPN, SEL FROM 3571TP	80009	151-0367-00
Q78	151-0221-00			TRANSISTOR: SILICON, PNP	80009	151-0221-00
Q82	151-0198-00			TRANSISTOR: SILICON, NPN, SEL FROM MPS918	80009	151-0198-00
Q84	151-0302-00			TRANSISTOR: SILICON, NPN	04713	2N2222A
Q86	151-0302-00			TRANSISTOR: SILICON, NPN	04713	2N2222A
Q100	151-0367-00			TRANSISTOR: SILICON, NPN, SEL FROM 3571TP	80009	151-0367-00
Q102	151-0367-00			TRANSISTOR: SILICON, NPN, SEL FROM 3571TP	80009	151-0367-00
Q117	151-0221-00			TRANSISTOR: SILICON, PNP	80009	151-0221-00
Q121	151-0221-00			TRANSISTOR: SILICON, PNP	80009	151-0221-00
Q124	151-0223-00			TRANSISTOR: SILICON, NPN	80009	151-0223-00
Q133	151-0282-00			TRANSISTOR: SILICON, NPN	02735	2N5179
Q138	151-0367-00			TRANSISTOR: SILICON, NPN, SEL FROM 3571TP	80009	151-0367-00
Q143	151-0367-00			TRANSISTOR: SILICON, NPN, SEL FROM 3571TP	80009	151-0367-00
Q149	151-0223-00			TRANSISTOR: SILICON, NPN	80009	151-0223-00
Q159	151-0223-00			TRANSISTOR: SILICON, NPN	80009	151-0223-00
Q173	151-0282-00	B010100	B039999	TRANSISTOR: SILICON, NPN	02735	2N5179
Q173	151-0212-00	B040000		TRANSISTOR: SILICON, NPN	80009	151-0212-00
Q178	151-0367-00	B010100	B039999	TRANSISTOR: SILICON, NPN, SEL FROM 3571TP	80009	151-0367-00
Q178	151-0212-00	B040000		TRANSISTOR: SILICON, NPN	80009	151-0212-00
Q183	151-0223-00			TRANSISTOR: SILICON, NPN	80009	151-0223-00
Q188	151-0223-00			TRANSISTOR: SILICON, NPN	80009	151-0223-00
Q192	151-0220-00			TRANSISTOR: SILICON, PNP	80009	151-0220-00
Q194	151-0220-00			TRANSISTOR: SILICON, PNP	80009	151-0220-00
Q198	151-0192-00			TRANSISTOR: SILICON, NPN, SEL FROM MPS6521	80009	151-0192-00
Q225	151-0220-00			TRANSISTOR: SILICON, PNP	80009	151-0220-00
Q227	151-0223-00			TRANSISTOR: SILICON, NPN	80009	151-0223-00

¹Part of Circuit Board.

Ckt No.	Tektronix Part No.	Serial/Model No. Eff	Dscont	Name & Description	Mfr Code	Mfr Part Number
Q257	151-0298-00			TRANSISTOR:SILICON,NPN	04713	SS4157
Q261	151-0298-00			TRANSISTOR:SILICON,NPN	04713	SS4157
Q265	151-0367-00			TRANSISTOR:SILICON,NPN,SEL FROM 3571TP	80009	151-0367-00
Q274	151-0271-00			TRANSISTOR:SILICON,PNP	80009	151-0271-00
Q277	151-0271-00			TRANSISTOR:SILICON,PNP	80009	151-0271-00
Q285	151-0190-02			TRANSISTOR:SILICON,NPN	80009	151-0190-02
Q288	151-0190-02			TRANSISTOR:SILICON,NPN	80009	151-0190-02
Q291	151-0190-02			TRANSISTOR:SILICON,NPN	80009	151-0190-02
Q294	151-0190-02			TRANSISTOR:SILICON,NPN	80009	151-0190-02
Q297	151-0190-02			TRANSISTOR:SILICON,NPN	80009	151-0190-02
Q300	151-0190-02			TRANSISTOR:SILICON,NPN	80009	151-0190-02
Q303	151-0190-02			TRANSISTOR:SILICON,NPN	80009	151-0190-02
Q306	151-0190-02			TRANSISTOR:SILICON,NPN	80009	151-0190-02
Q310	151-0190-02			TRANSISTOR:SILICON,NPN	80009	151-0190-02
Q312	151-0190-02			TRANSISTOR:SILICON,NPN	80009	151-0190-02
Q316	151-0333-00			TRANSISTOR:SILICON,NPN,SEL FROM MPS918	80009	151-0333-00
Q319	151-0333-00			TRANSISTOR:SILICON,NPN,SEL FROM MPS918	80009	151-0333-00
Q324	151-0221-00			TRANSISTOR:SILICON,PNP	80009	151-0221-00
Q340	151-0216-00			TRANSISTOR:SILICON,PNP	04713	MPS6523
Q343	151-0192-00			TRANSISTOR:SILICON,NPN,SEL FROM MPS6521	80009	151-0192-00
Q347	151-0127-00			TRANSISTOR:SILICON,NPN	80009	151-0127-00
Q351	151-0221-00			TRANSISTOR:SILICON,PNP	80009	151-0221-00
Q356	151-0367-00			TRANSISTOR:SILICON,NPN,SEL FROM 3571TP	80009	151-0367-00
Q358	151-0223-00			TRANSISTOR:SILICON,NPN	80009	151-0223-00
Q364	151-0127-00			TRANSISTOR:SILICON,NPN	80009	151-0127-00
Q371	151-0367-00			TRANSISTOR:SILICON,NPN,SEL FROM 3571TP	80009	151-0367-00
Q375	151-0282-00			TRANSISTOR:SILICON,NPN	02735	2N5179
Q383	151-0367-00			TRANSISTOR:SILICON,NPN,SEL FROM 3571TP	80009	151-0367-00
Q388	151-0271-00			TRANSISTOR:SILICON,PNP	80009	151-0271-00
Q391	151-0271-00			TRANSISTOR:SILICON,PNP	80009	151-0271-00
Q401	151-0333-00			TRANSISTOR:SILICON,NPN,SEL FROM MPS918	80009	151-0333-00
Q404	151-0190-02			TRANSISTOR:SILICON,NPN	80009	151-0190-02
Q406	151-0333-00			TRANSISTOR:SILICON,NPN,SEL FROM MPS918	80009	151-0333-00
Q409	151-0190-02			TRANSISTOR:SILICON,NPN	80009	151-0190-02
Q411	151-0333-00			TRANSISTOR:SILICON,NPN,SEL FROM MPS918	80009	151-0333-00
Q414	151-0190-02			TRANSISTOR:SILICON,NPN	80009	151-0190-02
Q416	151-0333-00			TRANSISTOR:SILICON,NPN,SEL FROM MPS918	80009	151-0333-00
Q419	151-0190-02			TRANSISTOR:SILICON,NPN	80009	151-0190-02
Q421	151-0333-00			TRANSISTOR:SILICON,NPN,SEL FROM MPS918	80009	151-0333-00
Q424	151-0190-02			TRANSISTOR:SILICON,NPN	80009	151-0190-02
Q431	151-0333-00			TRANSISTOR:SILICON,NPN,SEL FROM MPS918	80009	151-0333-00
Q433	151-0333-00			TRANSISTOR:SILICON,NPN,SEL FROM MPS918	80009	151-0333-00
Q440	151-0221-00			TRANSISTOR:SILICON,PNP	80009	151-0221-00
Q502	151-0221-00	B010100	B019999	TRANSISTOR:SILICON,PNP	80009	151-0221-00
Q502	151-0135-00	B020000		TRANSISTOR:GERMANIUM,PNP	04713	2N2635
Q504	151-0221-00			TRANSISTOR:SILICON,PNP	80009	151-0221-00
Q508	151-0282-00	B010100	B019999	TRANSISTOR:SILICON,NPN	02735	2N5179
Q508	151-0424-00	B020000		TRANSISTOR:SILICON,NPN	80009	151-0424-00
Q512	151-0221-00	B010100	B019999	TRANSISTOR:SILICON,PNP	80009	151-0221-00
Q512	151-0135-00	B020000		TRANSISTOR:GERMANIUM,PNP	04713	2N2635
Q514	151-0221-00			TRANSISTOR:SILICON,PNP	80009	151-0221-00
Q518	151-0282-00	B010100	B019999	TRANSISTOR:SILICON,NPN	02735	2N5179
Q518	151-0424-00	B020000		TRANSISTOR:SILICON,NPN	80009	151-0424-00

Replaceable Electrical Parts—7D11

Ckt No.	Tektronix Part No.	Serial/Model No. Eff	Discont	Name & Description	Mfr Code	Mfr Part Number
Q525	151-0221-00			TRANSISTOR:SILICON,PNP	80009	151-0221-00
Q532	151-0220-00			TRANSISTOR:SILICON,PNP	80009	151-0220-00
Q538	151-0223-00			TRANSISTOR:SILICON,NPN	80009	151-0223-00
Q546	151-0223-00			TRANSISTOR:SILICON,NPN	80009	151-0223-00
Q547	151-0220-00			TRANSISTOR:SILICON,PNP	80009	151-0220-00
Q562	151-0259-00			TRANSISTOR:SILICON,NPN	80009	151-0259-00
Q565	151-0259-00			TRANSISTOR:SILICON,NPN	80009	151-0259-00
Q568	151-0271-00			TRANSISTOR:SILICON,PNP	80009	151-0271-00
Q582	151-0259-00			TRANSISTOR:SILICON,NPN	80009	151-0259-00
Q588	151-0188-00	XB030000		TRANSISTOR:SILICON,PNP	01295	2N3906
Q595	151-0188-00			TRANSISTOR:SILICON,PNP	01295	2N3906
Q610A,B	151-1011-00			TRANSISTOR:SILICON,JFE,N-CHANNEL,DUAL	80009	151-1011-00
Q620	151-0220-00			TRANSISTOR:SILICON,PNP	80009	151-0220-00
Q624	151-0220-00	B010100	B079999	TRANSISTOR:SILICON,PNP	80009	151-0220-00
Q624	151-0325-00	B080000		TRANSISTOR:SILICON,PNP,SEL FROM 2N4258	80009	151-0325-00
Q628	151-0333-00			TRANSISTOR:SILICON,NPN,SEL FROM MPS918	80009	151-0333-00
Q630	151-0333-00			TRANSISTOR:SILICON,NPN,SEL FROM MPS918	80009	151-0333-00
Q634	151-0220-00			TRANSISTOR:SILICON,PNP	80009	151-0220-00
Q637	151-0221-00	XB020000		TRANSISTOR:SILICON,PNP	80009	151-0221-00
Q640	151-0221-00	XB020000	B039999	TRANSISTOR:SILICON,PNP	80009	151-0221-00
Q640	151-0325-00	B040000		TRANSISTOR:SILICON,PNP,SEL FROM 2N4258	80009	151-0325-00
Q641	151-0223-00			TRANSISTOR:SILICON,NPN	80009	151-0223-00
Q645	151-0221-00			TRANSISTOR:SILICON,PNP	80009	151-0221-00
Q648	151-0221-00			TRANSISTOR:SILICON,PNP	80009	151-0221-00
Q653	151-0259-00	B010100	B019999	TRANSISTOR:SILICON,NPN	80009	151-0259-00
Q653	151-0212-00	B020000		TRANSISTOR:SILICON,NPN	80009	151-0212-00
Q662	151-0221-00			TRANSISTOR:SILICON,PNP	80009	151-0221-00
Q682	151-0220-00			TRANSISTOR:SILICON,PNP	80009	151-0220-00
Q684	151-0220-00			TRANSISTOR:SILICON,PNP	80009	151-0220-00
Q687	151-0223-00			TRANSISTOR:SILICON,NPN	80009	151-0223-00
Q705	151-0192-00			TRANSISTOR:SILICON,NPN,SEL FROM MPS6521	80009	151-0192-00
Q707	151-0192-00			TRANSISTOR:SILICON,NPN,SEL FROM MPS6521	80009	151-0192-00
Q718	151-0192-00			TRANSISTOR:SILICON,NPN,SEL FROM MPS6521	80009	151-0192-00
Q721	151-0216-00			TRANSISTOR:SILICON,PNP	04713	MPS6523
Q724	151-0220-00			TRANSISTOR:SILICON,PNP	80009	151-0220-00
Q727	151-0192-00			TRANSISTOR:SILICON,NPN,SEL FROM MPS6521	80009	151-0192-00
Q730	151-0223-00			TRANSISTOR:SILICON,NPN	80009	151-0223-00
Q733	151-1006-00			TRANSISTOR:SILICON,JFE,N-CHANNEL	80009	151-1006-00
Q738	151-0223-00			TRANSISTOR:SILICON,NPN	80009	151-0223-00
Q740	151-0192-00			TRANSISTOR:SILICON,NPN,SEL FROM MPS6521	80009	151-0192-00
Q743	151-0192-00			TRANSISTOR:SILICON,NPN,SEL FROM MPS6521	80009	151-0192-00
Q753	151-0192-00			TRANSISTOR:SILICON,NPN,SEL FROM MPS6521	80009	151-0192-00
Q755	151-0503-00			TRANSISTOR:SCR,30V,0.8A	04713	2N5060
Q835	151-0367-00			TRANSISTOR:SILICON,NPN,SEL FROM 3571TP	80009	151-0367-00
Q838	151-0367-00			TRANSISTOR:SILICON,NPN,SEL FROM 3571TP	80009	151-0367-00
Q900	151-1022-00			TRANSISTOR:SILICON,JFE,SEL FROM 2N4392	80009	151-1022-00
Q904	151-1022-00			TRANSISTOR:SILICON,JFE,SEL FROM 2N4392	80009	151-1022-00
Q908	151-1022-00			TRANSISTOR:SILICON,JFE,SEL FROM 2N4392	80009	151-1022-00
Q912	151-1022-00			TRANSISTOR:SILICON,JFE,SEL FROM 2N4392	80009	151-1022-00
Q916	151-1022-00			TRANSISTOR:SILICON,JFE,SEL FROM 2N4392	80009	151-1022-00
Q920	151-1022-00			TRANSISTOR:SILICON,JFE,SEL FROM 2N4392	80009	151-1022-00
Q924	151-1022-00			TRANSISTOR:SILICON,JFE,SEL FROM 2N4392	80009	151-1022-00
Q928	151-1022-00			TRANSISTOR:SILICON,JFE,SEL FROM 2N4392	80009	151-1022-00

Ckt No.	Tektronix Part No.	Serial/Model No. Eff	Dscont	Name & Description	Mfr Code	Mfr Part Number
Q968	151-0220-00			TRANSISTOR:SILICON,PNP	80009	151-0220-00
Q970	151-0220-00			TRANSISTOR:SILICON,PNP	80009	151-0220-00
Q978	151-0220-00			TRANSISTOR:SILICON,PNP	80009	151-0220-00
Q1025	151-0192-00			TRANSISTOR:SILICON,NPN,SEL FROM MPS6521	80009	151-0192-00
Q1028	151-0192-00			TRANSISTOR:SILICON,NPN,SEL FROM MPS6521	80009	151-0192-00
Q1034	151-0335-00			TRANSISTOR:SILICON,PNP	80009	151-0335-00
Q1036	151-0235-00			TRANSISTOR:SILICON,PNP	80009	151-0235-00
Q1038	151-0335-00			TRANSISTOR:SILICON,PNP	80009	151-0335-00
R1	315-0472-00			RES.,FXD,CMPSN:4.7K OHM,5%,0.25W	01121	CB4725
R2	315-0101-00			RES.,FXD,CMPSN:100 OHM,5%,0.25W	01121	CB1015
R4	315-0470-00			RES.,FXD,CMPSN:47 OHM,5%,0.25W	01121	CB4705
R6	321-0448-00			RES.,FXD,FILM:453K OHM,1%,0.125W	91637	MFF1816G45302F
R7	321-0361-00			RES.,FXD,FILM:56.2K OHM,1%,0.125W	91637	MFF1816G56201F
R9	315-0470-00			RES.,FXD,CMPSN:47 OHM,5%,0.25W	01121	CB4705
R12	321-0452-00			RES.,FXD,FILM:499K OHM,1%,0.125W	91637	MFF1816G49902F
R13	315-0510-00			RES.,FXD,CMPSN:51 OHM,5%,0.25W	01121	CB5105
R21	315-0392-00			RES.,FXD,CMPSN:3.9K OHM,5%,0.25W	01121	CB3925
R22	315-0183-00			RES.,FXD,CMPSN:18K OHM,5%,0.25W	01121	CB1835
R24	315-0221-00			RES.,FXD,CMPSN:220 OHM,5%,0.25W	01121	CB2215
R26	315-0562-00			RES.,FXD,CMPSN:5.6K OHM,5%,0.25W	01121	CB5625
R27	315-0202-00			RES.,FXD,CMPSN:2K OHM,5%,0.25W	01121	CB2025
R28	315-0682-00			RES.,FXD,CMPSN:6.8K OHM,5%,0.25W	01121	CB6825
R30	321-0452-00			RES.,FXD,FILM:499K OHM,1%,0.125W	91637	MFF1816G49902F
R32	315-0101-00			RES.,FXD,CMPSN:100 OHM,5%,0.25W	01121	CB1015
R35	315-0511-00			RES.,FXD,CMPSN:510 OHM,5%,0.25W	01121	CB5115
R37	315-0102-00			RES.,FXD,CMPSN:1K OHM,5%,0.25W	01121	CB1025
R38	315-0202-00			RES.,FXD,CMPSN:2K OHM,5%,0.25W	01121	CB2025
R41	315-0510-00			RES.,FXD,CMPSN:51 OHM,5%,0.25W	01121	CB5105
R42	315-0751-00			RES.,FXD,CMPSN:750 OHM,5%,0.25W	01121	CB7515
R44	315-0820-00			RES.,FXD,CMPSN:82 OHM,5%,0.25W	01121	CB8205
R46	315-0510-00			RES.,FXD,CMPSN:51 OHM,5%,0.25W	01121	CB5105
R48	321-0199-00			RES.,FXD,FILM:1.15K OHM,1%,0.125W	91637	MFF1816G11500F
R49	311-0634-00			RES.,VAR,NONWIR:500 OHM,10%,0.50W	80740	62-55-3
R50	321-0239-00			RES.,FXD,FILM:3.01K OHM,1%,0.125W	91637	MFF1816G30100F
R52	315-0510-00			RES.,FXD,CMPSN:51 OHM,5%,0.25W	01121	CB5105
R55	321-0072-00			RES.,FXD,FILM:54.9 OHM,1%,0.125W	91637	MFF1816G54R90F
R57	321-0072-00			RES.,FXD,FILM:54.9 OHM,1%,0.125W	91637	MFF1816G54R90F
R60	322-0212-00			RES.,FXD,FILM:1.58K OHM,1%,0.25W	75042	CEBTO-1581F
R61	321-0113-00			RES.,FXD,FILM:147 OHM,1%,0.125W	91637	MFF1816G147ROF
R63	321-0113-00			RES.,FXD,FILM:147 OHM,1%,0.125W	91637	MFF1816G147ROF
R64	322-0210-00			RES.,FXD,FILM:1.5K OHM,1%,0.25W	75042	CEBTO-1501F
R66	321-0113-00			RES.,FXD,FILM:147 OHM,1%,0.125W	91637	MFF1816G147ROF
R68	321-0113-00			RES.,FXD,FILM:147 OHM,1%,0.125W	91637	MFF1816G147ROF
R69	322-0210-00			RES.,FXD,FILM:1.5K OHM,1%,0.25W	75042	CEBTO-1501F
R71	322-0175-00			RES.,FXD,FILM:649 OHM,1%,0.25W	75042	CEBTO-6490F
R73	322-0239-00			RES.,FXD,FILM:3.01K OHM,1%,0.25W	75042	CEBTO-3011F
R75	315-0101-00			RES.,FXD,CMPSN:100 OHM,5%,0.25W	01121	CB1015
R76	323-0197-00			RES.,FXD,FILM:1.1K OHM,1%,0.50W	75042	CECTO-1101F
R77	311-0622-00			RES.,VAR,NONWIR:100 OHM,10%,0.50W	32997	3326H-G48-101
R78	322-0172-00			RES.,FXD,FILM:604 OHM,1%,0.25W	75042	CEBTO-6040F
R79	321-0211-00			RES.,FXD,FILM:1.54K OHM,1%,0.125W	91637	MFF1816G15400F
R80	315-0680-00			RES.,FXD,CMPSN:68 OHM,5%,0.25W	01121	CB6805
R82	315-0103-00			RES.,FXD,CMPSN:10K OHM,5%,0.25W	01121	CB1035

Replaceable Electrical Parts—7D11

Ckt No.	Tektronix Part No.	Serial/Model No. Eff	Dscont	Name & Description	Mfr Code	Mfr Part Number
R84	315-0303-00			RES., FXD, CMPSN:30K OHM, 5%, 0.25W	01121	CB3035
R86	315-0303-00			RES., FXD, CMPSN:30K OHM, 5%, 0.25W	01121	CB3035
R89	315-0222-00			RES., FXD, CMPSN:2.2K OHM, 5%, 0.25W	01121	CB2225
R92	315-0101-00			RES., FXD, CMPSN:100 OHM, 5%, 0.25W	01121	CB1015
R96	315-0101-00			RES., FXD, CMPSN:100 OHM, 5%, 0.25W	01121	CB1015
R101	315-0150-00			RES., FXD, CMPSN:15 OHM, 5%, 0.25W	01121	CB1505
R103	315-0150-00			RES., FXD, CMPSN:15 OHM, 5%, 0.25W	01121	CB1505
R104	315-0162-00			RES., FXD, CMPSN:1.6K OHM, 5%, 0.25W	01121	CB1625
R107	SELECTED					
R108	315-0222-00			RES., FXD, CMPSN:2.2K OHM, 5%, 0.25W	01121	CB2225
R109	315-0123-00			RES., FXD, CMPSN:12K OHM, 5%, 0.25W	01121	CB1235
R111 ¹	311-1192-00			RES., VAR, NONWIR:10K OHM, 20%, 1W	71590	BR-232-001
R113	315-0101-00			RES., FXD, CMPSN:100 OHM, 5%, 0.25W	01121	CB1015
R115	315-0101-00			RES., FXD, CMPSN:100 OHM, 5%, 0.25W	01121	CB1015
R118	321-0193-00			RES., FXD, FILM:1K OHM, 1%, 0.125W	91637	MFF1816G10000F
R119	315-0300-00			RES., FXD, CMPSN:30 OHM, 5%, 0.25W	01121	CB3005
R120	321-0193-00			RES., FXD, FILM:1K OHM, 1%, 0.125W	91637	MFF1816G10000F
R122	315-0622-00			RES., FXD, CMPSN:6.2K OHM, 5%, 0.25W	01121	CB6225
R124	315-0302-00			RES., FXD, CMPSN:3K OHM, 5%, 0.25W	01121	CB3025
R126	315-0622-00			RES., FXD, CMPSN:6.2K OHM, 5%, 0.25W	01121	CB6225
R128	315-0202-00	B010100	B029999	RES., FXD, CMPSN:2K OHM, 5%, 0.25W	01121	CB2025
R128	315-0242-00	B030000		RES., FXD, CMPSN:2.4K OHM, 5%, 0.25W	01121	CB2425
R130	315-0101-00			RES., FXD, CMPSN:100 OHM, 5%, 0.25W	01121	CB1015
R132	315-0270-00			RES., FXD, CMPSN:27 OHM, 5%, 0.25W	01121	CB2705
R133	315-0221-00			RES., FXD, CMPSN:220 OHM, 5%, 0.25W	01121	CB2215
R134	315-0121-00			RES., FXD, CMPSN:120 OHM, 5%, 0.25W	01121	CB1215
R135	315-0300-00			RES., FXD, CMPSN:30 OHM, 5%, 0.25W	01121	CB3005
R137	315-0150-00			RES., FXD, CMPSN:15 OHM, 5%, 0.25W	01121	CB1505
R138	315-0331-00	B010100	B029999	RES., FXD, CMPSN:330 OHM, 5%, 0.25W	01121	CB3315
R138	315-0241-00	B030000		RES., FXD, CMPSN:240 OHM, 5%, 0.25W	01121	CB2415
R139	323-0192-00			RES., FXD, FILM:976 OHM, 1%, 0.50W	75042	CECT0-9760F
R140	315-0242-00	XB030000		RES., FXD, CMPSN:2.4K OHM, 5%, 0.25W	01121	CB2425
R141	315-0360-00			RES., FXD, CMPSN:36 OHM, 5%, 0.25W	01121	CB3605
R143	315-0331-00			RES., FXD, CMPSN:330 OHM, 5%, 0.25W	01121	CB3315
R145	315-0470-00			RES., FXD, CMPSN:47 OHM, 5%, 0.25W	01121	CB4705
R147	315-0471-00			RES., FXD, CMPSN:470 OHM, 5%, 0.25W	01121	CB4715
R148	315-0202-00			RES., FXD, CMPSN:2K OHM, 5%, 0.25W	01121	CB2025
R150	315-0101-00			RES., FXD, CMPSN:100 OHM, 5%, 0.25W	01121	CB1015
R151	311-0635-00			RES., VAR, NONWIR:1K OHM, 10%, 0.50W	80740	62-56-3
R152	315-0162-00			RES., FXD, CMPSN:1.6K OHM, 5%, 0.25W	01121	CB1625
R154	315-0470-00			RES., FXD, CMPSN:47 OHM, 5%, 0.25W	01121	CB4705
R156	315-0471-00			RES., FXD, CMPSN:470 OHM, 5%, 0.25W	01121	CB4715
R157	315-0202-00			RES., FXD, CMPSN:2K OHM, 5%, 0.25W	01121	CB2025
R160	315-0201-00			RES., FXD, CMPSN:200 OHM, 5%, 0.25W	01121	CB2015
R161	311-0634-00			RES., VAR, NONWIR:500 OHM, 10%, 0.50W	80740	62-55-3
R162	315-0821-00			RES., FXD, CMPSN:820 OHM, 5%, 0.25W	01121	CB8215
R164	315-0391-00			RES., FXD, CMPSN:390 OHM, 5%, 0.25W	01121	CB3915
R166	315-0470-00			RES., FXD, CMPSN:47 OHM, 5%, 0.25W	01121	CB4705
R168	315-0470-00			RES., FXD, CMPSN:47 OHM, 5%, 0.25W	01121	CB4705
R170	315-0101-00			RES., FXD, CMPSN:100 OHM, 5%, 0.25W	01121	CB1015
R172	315-0270-00			RES., FXD, CMPSN:27 OHM, 5%, 0.25W	01121	CB2705
R173	315-0221-00			RES., FXD, CMPSN:220 OHM, 5%, 0.25W	01121	CB2215
R174	315-0121-00			RES., FXD, CMPSN:120 OHM, 5%, 0.25W	01121	CB1215

¹Furnished as a unit with S111.

Ckt No.	Tektronix Part No.	Serial/Model No. Eff	Dscont	Name & Description	Mfr Code	Mfr Part Number
R175	315-0300-00			RES., FXD, CMPSN: 30 OHM, 5%, 0.25W	01121	CB3005
R177	315-0150-00			RES., FXD, CMPSN: 15 OHM, 5%, 0.25W	01121	CB1505
R178	315-0331-00	B010100	B039999	RES., FXD, CMPSN: 330 OHM, 5%, 0.25W	01121	CB3315
R178	315-0301-00	B040000		RES., FXD, CMPSN: 300 OHM, 5%, 0.25W	01121	CB3015
R179	323-0192-00			RES., FXD, FILM: 976 OHM, 1%, 0.50W	75042	CECT0-9760F
R181	315-0202-00			RES., FXD, CMPSN: 2K OHM, 5%, 0.25W	01121	CB2025
R182	315-0301-00			RES., FXD, CMPSN: 300 OHM, 5%, 0.25W	01121	CB3015
R184	315-0303-00			RES., FXD, CMPSN: 30K OHM, 5%, 0.25W	01121	CB3035
R185	315-0183-00			RES., FXD, CMPSN: 18K OHM, 5%, 0.25W	01121	CB1835
R186	315-0131-00			RES., FXD, CMPSN: 130 OHM, 5%, 0.25W	01121	CB1315
R188	315-0101-00			RES., FXD, CMPSN: 100 OHM, 5%, 0.25W	01121	CB1015
R189	315-0152-00			RES., FXD, CMPSN: 1.5K OHM, 5%, 0.25W	01121	CB1525
R190	315-0154-00			RES., FXD, CMPSN: 150K OHM, 5%, 0.25W	01121	CB1545
R191	315-0223-00			RES., FXD, CMPSN: 22K OHM, 5%, 0.25W	01121	CB2235
R193	315-0332-00			RES., FXD, CMPSN: 3.3K OHM, 5%, 0.25W	01121	CB3325
R195	315-0223-00			RES., FXD, CMPSN: 22K OHM, 5%, 0.25W	01121	CB2235
R196	315-0912-00			RES., FXD, CMPSN: 9.1K OHM, 5%, 0.25W	01121	CB9125
R197	315-0151-00			RES., FXD, CMPSN: 150 OHM, 5%, 0.25W	01121	CB1515
R198	315-0270-00			RES., FXD, CMPSN: 27 OHM, 5%, 0.25W	01121	CB2705
R200	315-0220-00			RES., FXD, CMPSN: 22 OHM, 5%, 0.25W	01121	CB2205
R206	315-0331-00			RES., FXD, CMPSN: 330 OHM, 5%, 0.25W	01121	CB3315
R207	315-0271-00			RES., FXD, CMPSN: 270 OHM, 5%, 0.25W	01121	CB2715
R220	323-0068-00			RES., FXD, FILM: 49.9 OHM, 1%, 0.50W	75042	CECT0-49R90F
R222	315-0102-00			RES., FXD, CMPSN: 1K OHM, 5%, 0.25W	01121	CB1025
R225	315-0432-00	B010100	B059999	RES., FXD, CMPSN: 4.3K OHM, 5%, 0.25W	01121	CB4325
R225	315-0681-00	B060000		RES., FXD, CMPSN: 680 OHM, 5%, 0.25W	01121	CB6815
R227	315-0681-00			RES., FXD, CMPSN: 680 OHM, 5%, 0.25W	01121	CB6815
R234	315-0103-00			RES., FXD, CMPSN: 10K OHM, 5%, 0.25W	01121	CB1035
R235	315-0103-00			RES., FXD, CMPSN: 10K OHM, 5%, 0.25W	01121	CB1035
R237	315-0103-00			RES., FXD, CMPSN: 10K OHM, 5%, 0.25W	01121	CB1035
R239	315-0153-00			RES., FXD, CMPSN: 15K OHM, 5%, 0.25W	01121	CB1535
R241	315-0680-00			RES., FXD, CMPSN: 68 OHM, 5%, 0.25W	01121	CB6805
R242	321-0437-00			RES., FXD, FILM: 348K OHM, 1%, 0.125W	91637	MFF1816G34802F
R244	315-0111-00			RES., FXD, CMPSN: 110 OHM, 5%, 0.25W	01121	CB1115
R245	315-0512-00			RES., FXD, CMPSN: 5.1K OHM, 5%, 0.25W	01121	CB5125
R247	315-0432-00			RES., FXD, CMPSN: 4.3K OHM, 5%, 0.25W	01121	CB4325
R248	315-0622-00			RES., FXD, CMPSN: 6.2K OHM, 5%, 0.25W	01121	CB6225
R249	315-0472-00			RES., FXD, CMPSN: 4.7K OHM, 5%, 0.25W	01121	CB4725
R251	315-0472-00			RES., FXD, CMPSN: 4.7K OHM, 5%, 0.25W	01121	CB4725
R254	315-0272-00			RES., FXD, CMPSN: 2.7K OHM, 5%, 0.25W	01121	CB2725
R255	315-0271-00			RES., FXD, CMPSN: 270 OHM, 5%, 0.25W	01121	CB2715
R258	315-0821-00			RES., FXD, CMPSN: 820 OHM, 5%, 0.25W	01121	CB8215
R262	315-0471-00			RES., FXD, CMPSN: 470 OHM, 5%, 0.25W	01121	CB4715
R263	315-0202-00			RES., FXD, CMPSN: 2K OHM, 5%, 0.25W	01121	CB2025
R266	315-0821-00			RES., FXD, CMPSN: 820 OHM, 5%, 0.25W	01121	CB8215
R268	315-0152-00			RES., FXD, CMPSN: 1.5K OHM, 5%, 0.25W	01121	CB1525
R270	321-0162-00			RES., FXD, FILM: 475 OHM, 1%, 0.125W	91637	MFF1816G475R0F
R271	321-0034-00			RES., FXD, FILM: 22.1 OHM, 1%, 0.125W	91637	MFF1816G22R10F
R273	315-0470-00			RES., FXD, CMPSN: 47 OHM, 5%, 0.25W	01121	CB4705
R275	301-0102-00			RES., FXD, CMPSN: 1K OHM, 5%, 0.50W	01121	EB1025
R276	315-0100-00			RES., FXD, CMPSN: 10 OHM, 5%, 0.25W	01121	CB1005
R278	321-0191-00			RES., FXD, FILM: 953 OHM, 1%, 0.125W	91637	MFF1816G953R0F
R279	321-0064-00			RES., FXD, FILM: 45.3 OHM, 1%, 0.125W	91637	MFF1816G45R30F

Replaceable Electrical Parts—7D11

Ckt No.	Tektronix Part No.	Serial/Model No. Eff	Dscont	Name & Description	Mfr Code	Mfr Part Number
R281	321-0097-00			RES.,FXD,FILM:100 OHM,1%,0.125W	91637	MFF1816G100ROF
R282	322-0155-00			RES.,FXD,FILM:402 OHM,1%,0.25W	75042	CEBTO-4020F
R284	315-0100-00			RES.,FXD,CMPSN:10 OHM,5%,0.25W	01121	CB1005
R286	321-0114-00			RES.,FXD,FILM:150 OHM,1%,0.125W	91637	MFF1816G150ROF
R287	315-0302-00			RES.,FXD,CMPSN:3K OHM,5%,0.25W	01121	CB3025
R289	315-0112-00			RES.,FXD,CMPSN:1.1K OHM,5%,0.25W	01121	CB1125
R292	321-0114-00			RES.,FXD,FILM:150 OHM,1%,0.125W	91637	MFF1816G150ROF
R293	315-0302-00			RES.,FXD,CMPSN:3K OHM,5%,0.25W	01121	CB3025
R295	315-0112-00			RES.,FXD,CMPSN:1.1K OHM,5%,0.25W	01121	CB1125
R298	321-0114-00			RES.,FXD,FILM:150 OHM,1%,0.125W	91637	MFF1816G150ROF
R299	315-0302-00			RES.,FXD,CMPSN:3K OHM,5%,0.25W	01121	CB3025
R301	315-0112-00			RES.,FXD,CMPSN:1.1K OHM,5%,0.25W	01121	CB1125
R304	321-0114-00			RES.,FXD,FILM:150 OHM,1%,0.125W	91637	MFF1816G150ROF
R305	315-0302-00			RES.,FXD,CMPSN:3K OHM,5%,0.25W	01121	CB3025
R307	315-0112-00			RES.,FXD,CMPSN:1.1K OHM,5%,0.25W	01121	CB1125
R310	321-0114-00			RES.,FXD,FILM:150 OHM,1%,0.125W	91637	MFF1816G150ROF
R311	315-0302-00			RES.,FXD,CMPSN:3K OHM,5%,0.25W	01121	CB3025
R313	315-0112-00			RES.,FXD,CMPSN:1.1K OHM,5%,0.25W	01121	CB1125
R315	315-0511-00			RES.,FXD,CMPSN:510 OHM,5%,0.25W	01121	CB5115
R316	321-0143-00			RES.,FXD,FILM:301 OHM,1%,0.125W	91637	MFF1816G301ROF
R318	321-0176-00			RES.,FXD,FILM:665 OHM,1%,0.125W	91637	MFF1816G665ROF
R320	315-0511-00			RES.,FXD,CMPSN:510 OHM,5%,0.25W	01121	CB5115
R322	321-0140-00			RES.,FXD,FILM:280 OHM,1%,0.125W	91637	MFF1816G280ROF
R324	315-0561-00			RES.,FXD,CMPSN:560 OHM,5%,0.25W	01121	CB5615
R326	315-0472-00			RES.,FXD,CMPSN:4.7K OHM,5%,0.25W	01121	CB4725
R330	321-0200-00			RES.,FXD,FILM:1.18K OHM,1%,0.125W	91637	MFF1816G11800F
R331	311-1224-00			RES.,VAR,NONWIR:500 OHM,20%,0.50W	32997	3386F-T04-501
R332	321-0222-00			RES.,FXD,FILM:2K OHM,1%,0.125W	91637	MFF1816G20000F
R333	311-1224-00			RES.,VAR,NONWIR:500 OHM,20%,0.50W	32997	3386F-T04-501
R334	321-0174-00			RES.,FXD,FILM:634 OHM,1%,0.125W	91637	MFF1816G634ROF
R336	311-1376-00			RES.,VAR,WW:10K OHM,5%,2W	02111	140-416
R340	315-0204-00			RES.,FXD,CMPSN:200K OHM,5%,0.25W	01121	CB2045
R343	321-0251-00			RES.,FXD,FILM:4.02K OHM,1%,0.125W	91637	MFF1816G40200F
R344	321-0193-00			RES.,FXD,FILM:1K OHM,1%,0.125W	91637	MFF1816G10000F
R346	321-0163-00			RES.,FXD,FILM:487 OHM,1%,0.125W	91637	MFF1816G487ROF
R347	315-0101-00			RES.,FXD,CMPSN:100 OHM,5%,0.25W	01121	CB1015
R349	315-0202-00			RES.,FXD,CMPSN:2K OHM,5%,0.25W	01121	CB2025
R351	315-0102-00			RES.,FXD,CMPSN:1K OHM,5%,0.25W	01121	CB1025
R353	315-0471-00			RES.,FXD,CMPSN:470 OHM,5%,0.25W	01121	CB4715
R354	315-0332-00			RES.,FXD,CMPSN:3.3K OHM,5%,0.25W	01121	CB3325
R356	321-0260-00			RES.,FXD,FILM:4.99K OHM,1%,0.125W	91637	MFF1816G49900F
R357	321-0168-00			RES.,FXD,FILM:549 OHM,1%,0.125W	91637	MFF1816G549ROF
R358	315-0181-00			RES.,FXD,CMPSN:180 OHM,5%,0.25W	01121	CB1815
R359	321-0193-00			RES.,FXD,FILM:1K OHM,1%,0.125W	91637	MFF1816G10000F
R361	321-0159-00			RES.,FXD,FILM:442 OHM,1%,0.125W	91637	MFF1816G442ROF
R362	321-0193-00			RES.,FXD,FILM:1K OHM,1%,0.125W	91637	MFF1816G10000F
R364	315-0241-00			RES.,FXD,CMPSN:240 OHM,5%,0.25W	01121	CB2415
R365	315-0222-00			RES.,FXD,CMPSN:2.2K OHM,5%,0.25W	01121	CB2225
R367	321-0155-00			RES.,FXD,FILM:402 OHM,1%,0.125W	91637	MFF1816G402ROF
R368	321-0184-00			RES.,FXD,FILM:806 OHM,1%,0.125W	91637	MFF1816G806ROF
R369	321-0184-00			RES.,FXD,FILM:806 OHM,1%,0.125W	91637	MFF1816G806ROF
R371	315-0221-00			RES.,FXD,CMPSN:220 OHM,5%,0.25W	01121	CB2215
R372	315-0121-00			RES.,FXD,CMPSN:120 OHM,5%,0.25W	01121	CB1215

Ckt No.	Tektronix Part No.	Serial/Model No. Eff	Dscont	Name & Description	Mfr Code	Mfr Part Number
R373	315-0300-00			RES., FXD, CMPSN:30 OHM, 5%, 0.25W	01121	CB3005
R375	321-0132-00			RES., FXD, FILM:232 OHM, 1%, 0.125W	91637	MFF1816G232ROF
R376	301-0102-00			RES., FXD, CMPSN:1K OHM, 5%, 0.50W	01121	EB1025
R377	321-0134-00			RES., FXD, FILM:243 OHM, 1%, 0.125W	91637	MFF1816G243ROF
R378	321-0034-00			RES., FXD, FILM:22.1 OHM, 1%, 0.125W	91637	MFF1816G22R1OF
R381	315-0202-00			RES., FXD, CMPSN:2K OHM, 5%, 0.25W	01121	CB2025
R384	315-0152-00			RES., FXD, CMPSN:1.5K OHM, 5%, 0.25W	01121	CB1525
R385	315-0821-00			RES., FXD, CMPSN:820 OHM, 5%, 0.25W	01121	CB8215
R387	315-0470-00			RES., FXD, CMPSN:47 OHM, 5%, 0.25W	01121	CB4705
R389	301-0102-00			RES., FXD, CMPSN:1K OHM, 5%, 0.50W	01121	EB1025
R390	315-0680-00			RES., FXD, CMPSN:68 OHM, 5%, 0.25W	01121	CB6805
R392	321-0191-00			RES., FXD, FILM:953 OHM, 1%, 0.125W	91637	MFF1816G953ROF
R393	321-0064-00			RES., FXD, FILM:45.3 OHM, 1%, 0.125W	91637	MFF1816G45R3OF
R395	321-0093-00			RES., FXD, FILM:90.9 OHM, 1%, 0.125W	91637	MFF1816G90R9OF
R396	322-0171-00			RES., FXD, FILM:590 OHM, 1%, 0.25W	75042	CEBT0-5900F
R398	321-0199-00			RES., FXD, FILM:1.15K OHM, 1%, 0.125W	91637	MFF1816G11500F
R400	315-0100-00			RES., FXD, CMPSN:10 OHM, 5%, 0.25W	01121	CB1005
R402	321-0114-00			RES., FXD, FILM:150 OHM, 1%, 0.125W	91637	MFF1816G150ROF
R403	315-0302-00			RES., FXD, CMPSN:3K OHM, 5%, 0.25W	01121	CB3025
R404	315-0112-00			RES., FXD, CMPSN:1.1K OHM, 5%, 0.25W	01121	CB1125
R407	321-0114-00			RES., FXD, FILM:150 OHM, 1%, 0.125W	91637	MFF1816G150ROF
R408	315-0302-00			RES., FXD, CMPSN:3K OHM, 5%, 0.25W	01121	CB3025
R409	315-0112-00			RES., FXD, CMPSN:1.1K OHM, 5%, 0.25W	01121	CB1125
R412	321-0114-00			RES., FXD, FILM:150 OHM, 1%, 0.125W	91637	MFF1816G150ROF
R413	315-0302-00			RES., FXD, CMPSN:3K OHM, 5%, 0.25W	01121	CB3025
R414	315-0112-00			RES., FXD, CMPSN:1.1K OHM, 5%, 0.25W	01121	CB1125
R417	321-0114-00			RES., FXD, FILM:150 OHM, 1%, 0.125W	91637	MFF1816G150ROF
R418	315-0302-00			RES., FXD, CMPSN:3K OHM, 5%, 0.25W	01121	CB3025
R419	315-0112-00			RES., FXD, CMPSN:1.1K OHM, 5%, 0.25W	01121	CB1125
R422	321-0114-00			RES., FXD, FILM:150 OHM, 1%, 0.125W	91637	MFF1816G150ROF
R423	315-0302-00			RES., FXD, CMPSN:3K OHM, 5%, 0.25W	01121	CB3025
R424	315-0112-00			RES., FXD, CMPSN:1.1K OHM, 5%, 0.25W	01121	CB1125
R430	315-0511-00			RES., FXD, CMPSN:510 OHM, 5%, 0.25W	01121	CB5115
R432	321-0176-00			RES., FXD, FILM:665 OHM, 1%, 0.125W	91637	MFF1816G665ROF
R434	315-0511-00			RES., FXD, CMPSN:510 OHM, 5%, 0.25W	01121	CB5115
R436	321-0143-00			RES., FXD, FILM:301 OHM, 1%, 0.125W	91637	MFF1816G301ROF
R438	321-0140-00			RES., FXD, FILM:280 OHM, 1%, 0.125W	91637	MFF1816G280ROF
R440	315-0561-00			RES., FXD, CMPSN:560 OHM, 5%, 0.25W	01121	CB5615
R443	315-0301-00			RES., FXD, CMPSN:300 OHM, 5%, 0.25W	01121	CB3015
R501	315-0470-00			RES., FXD, CMPSN:47 OHM, 5%, 0.25W	01121	CB4705
R506	315-0221-00			RES., FXD, CMPSN:220 OHM, 5%, 0.25W	01121	CB2215
R507	315-0102-00			RES., FXD, CMPSN:1K OHM, 5%, 0.25W	01121	CB1025
R510	315-0100-00			RES., FXD, CMPSN:10 OHM, 5%, 0.25W	01121	CB1005
R511	315-0470-00			RES., FXD, CMPSN:47 OHM, 5%, 0.25W	01121	CB4705
R516	315-0151-00			RES., FXD, CMPSN:150 OHM, 5%, 0.25W	01121	CB1515
R517	315-0102-00			RES., FXD, CMPSN:1K OHM, 5%, 0.25W	01121	CB1025
R519	315-0101-00			RES., FXD, CMPSN:100 OHM, 5%, 0.25W	01121	CB1015
R521	315-0101-00			RES., FXD, CMPSN:100 OHM, 5%, 0.25W	01121	CB1015
R522	315-0432-00	B010100	B019999	RES., FXD, CMPSN:4.3K OHM, 5%, 0.25W	01121	CB4325
R522	315-0152-00	B020000		RES., FXD, CMPSN:1.5K OHM, 5%, 0.25W	01121	CB1525
R524	315-0270-00			RES., FXD, CMPSN:27 OHM, 5%, 0.25W	01121	CB2705
R525	301-0471-00			RES., FXD, CMPSN:470 OHM, 5%, 0.50W	01121	EB4715
R527	315-0153-00			RES., FXD, CMPSN:15K OHM, 5%, 0.25W	01121	CB1535

Replaceable Electrical Parts—7D11

Ckt No.	Tektronix Part No.	Serial/Model No. Eff	Dscont	Name & Description	Mfr Code	Mfr Part Number
R528	315-0151-00			RES., FXD, CMPSN:150 OHM, 5%, 0.25W	01121	CB1515
R529	315-0121-00	B010100	B019999	RES., FXD, CMPSN:120 OHM, 5%, 0.25W	01121	CB1215
R529	315-0151-00	B020000		RES., FXD, CMPSN:150 OHM, 5%, 0.25W	01121	CB1515
R531	315-0512-00			RES., FXD, CMPSN:5.1K OHM, 5%, 0.25W	01121	CB5125
R532	315-0153-00			RES., FXD, CMPSN:15K OHM, 5%, 0.25W	01121	CB1535
R534	315-0621-00			RES., FXD, CMPSN:620 OHM, 5%, 0.25W	01121	CB6215
R535	315-0102-00			RES., FXD, CMPSN:1K OHM, 5%, 0.25W	01121	CB1025
R537	315-0182-00			RES., FXD, CMPSN:1.8K OHM, 5%, 0.25W	01121	CB1825
R538	315-0152-00			RES., FXD, CMPSN:1.5K OHM, 5%, 0.25W	01121	CB1525
R540	315-0102-00	B010100	B029999X	RES., FXD, CMPSN:1K OHM, 5%, 0.25W	01121	CB1025
R541	315-0160-00			RES., FXD, CMPSN:16 OHM, 5%, 0.25W	01121	CB1605
R542	315-0471-00			RES., FXD, CMPSN:470 OHM, 5%, 0.25W	01121	CB4715
R543	315-0102-00			RES., FXD, CMPSN:1K OHM, 5%, 0.25W	01121	CB1025
R545	315-0102-00			RES., FXD, CMPSN:1K OHM, 5%, 0.25W	01121	CB1025
R547	315-0620-00			RES., FXD, CMPSN:62 OHM, 5%, 0.25W	01121	CB6205
R548	315-0242-00			RES., FXD, CMPSN:2.4K OHM, 5%, 0.25W	01121	CB2425
R549	315-0822-00			RES., FXD, CMPSN:8.2K OHM, 5%, 0.25W	01121	CB8225
R555	315-0820-00			RES., FXD, CMPSN:82 OHM, 5%, 0.25W	01121	CB8205
R556	315-0201-00			RES., FXD, CMPSN:200 OHM, 5%, 0.25W	01121	CB2015
R560	315-0301-00			RES., FXD, CMPSN:300 OHM, 5%, 0.25W	01121	CB3015
R562	315-0221-00			RES., FXD, CMPSN:220 OHM, 5%, 0.25W	01121	CB2215
R563	315-0103-00			RES., FXD, CMPSN:10K OHM, 5%, 0.25W	01121	CB1035
R565	321-0104-00			RES., FXD, FILM:118 OHM, 1%, 0.125W	91637	MFF1816G118ROF
R566	323-0192-00			RES., FXD, FILM:976 OHM, 1%, 0.50W	75042	CECT0-9760F
R568	321-0014-00			RES., FXD, FILM:13.7 OHM, 1%, 0.125W	91637	MFF1816G137ROF
R571	315-0150-00			RES., FXD, CMPSN:15 OHM, 5%, 0.25W	01121	CB1505
R572	321-0069-00			RES., FXD, FILM:51.1 OHM, 1%, 0.125W	91637	MFF1816G51R10F
R577	321-0139-00			RES., FXD, FILM:274 OHM, 1%, 0.125W	91637	MFF1816G274ROF
R578	321-0110-00			RES., FXD, FILM:137 OHM, 1%, 0.125W	91637	MFF1816G137ROF
R581	315-0221-00			RES., FXD, CMPSN:220 OHM, 5%, 0.25W	01121	CB2215
R583	315-0222-00			RES., FXD, CMPSN:2.2K OHM, 5%, 0.25W	01121	CB2225
R584	315-0561-00			RES., FXD, CMPSN:560 OHM, 5%, 0.25W	01121	CB5615
R586	315-0102-00	XB030000		RES., FXD, CMPSN:1K OHM, 5%, 0.25W	01121	CB1025
R587	315-0103-00	XB030000		RES., FXD, CMPSN:10K OHM, 5%, 0.25W	01121	CB1035
R589	321-0335-00			RES., FXD, FILM:30.1K OHM, 1%, 0.125W	91637	MFF1816G30101F
R591	321-0290-00	B010100	B049999	RES., FXD, FILM:10.2K OHM, 1%, 0.125W	91637	MFF1816G10201F
R591	321-0281-00	B050000		RES., FXD, FILM:8.25K OHM, 1%, 0.125W	91637	MFF1816G82500F
R593	315-0221-00			RES., FXD, CMPSN:220 OHM, 5%, 0.25W	01121	CB2215
R596	315-0103-00			RES., FXD, CMPSN:10K OHM, 5%, 0.25W	01121	CB1035
R598	321-0329-00			RES., FXD, FILM:26.1K OHM, 1%, 0.125W	91637	MFF1816G26101F
R599	315-0512-00			RES., FXD, CMPSN:5.1K OHM, 5%, 0.25W	01121	CB5125
R601	315-0913-00			RES., FXD, CMPSN:91K OHM, 5%, 0.25W	01121	CB9135
R602	315-0101-00			RES., FXD, CMPSN:100 OHM, 5%, 0.25W	01121	CB1015
R604	315-0512-00			RES., FXD, CMPSN:5.1K OHM, 5%, 0.25W	01121	CB5125
R605	315-0512-00			RES., FXD, CMPSN:5.1K OHM, 5%, 0.25W	01121	CB5125
R607	315-0512-00			RES., FXD, CMPSN:5.1K OHM, 5%, 0.25W	01121	CB5125
R609	315-0914-00			RES., FXD, CMPSN:910K OHM, 5%, 0.25W	01121	CB9145
R610	315-0101-00			RES., FXD, CMPSN:100 OHM, 5%, 0.25W	01121	CB1015
R612	315-0511-00			RES., FXD, CMPSN:510 OHM, 5%, 0.25W	01121	CB5115
R615 ¹	311-1192-00			RES., VAR, NONWIR:10K OHM, 20%, 1W	71590	BR-232-001
R617	315-0472-00	B010100	B039999	RES., FXD, CMPSN:4.7K OHM, 5%, 0.25W	01121	CB4725
R617	315-0272-00	B040000		RES., FXD, CMPSN:2.7K OHM, 5%, 0.25W	01121	CB2725
R618	315-0132-00			RES., FXD, CMPSN:1.3K OHM, 5%, 0.25W	01121	CB1325

¹Furnished as a unit with S615.

Ckt No.	Tektronix Part No.	Serial/Model No. Eff	Dscont	Name & Description	Mfr Code	Mfr Part Number
R619	315-0103-00	XB040000		RES., FXD, CMPSN:10K OHM, 5%, 0.25W	01121	CB1035
R620	315-0331-00			RES., FXD, CMPSN:330 OHM, 5%, 0.25W	01121	CB3315
R622	315-0101-00			RES., FXD, CMPSN:100 OHM, 5%, 0.25W	01121	CB1015
R623	315-0392-00			RES., FXD, CMPSN:3.9K OHM, 5%, 0.25W	01121	CB3925
R624	315-0331-00			RES., FXD, CMPSN:330 OHM, 5%, 0.25W	01121	CB3315
R626	321-0227-00	B010100	B039999X	RES., FXD, FILM:2.26K OHM, 1%, 0.125W	91637	MFF1816G22600F
R627	315-0472-00	XB040000		RES., FXD, CMPSN:4.7K OHM, 5%, 0.25W	01121	CB4725
R629	321-0177-00			RES., FXD, FILM:681 OHM, 1%, 0.125W	91637	MFF1816G681R0F
R630	315-0472-00	XB040000		RES., FXD, CMPSN:4.7K OHM, 5%, 0.25W	01121	CB4725
R632	315-0222-00			RES., FXD, CMPSN:2.2K OHM, 5%, 0.25W	01121	CB2225
R633	315-0183-00			RES., FXD, CMPSN:18K OHM, 5%, 0.25W	01121	CB1835
R635	315-0471-00			RES., FXD, CMPSN:470 OHM, 5%, 0.25W	01121	CB4715
R636	315-0361-00			RES., FXD, CMPSN:360 OHM, 5%, 0.25W	01121	CB3615
R637	315-0331-00	XB020000		RES., FXD, CMPSN:330 OHM, 5%, 0.25W	01121	CB3315
R638	315-0331-00	XB020000		RES., FXD, CMPSN:330 OHM, 5%, 0.25W	01121	CB3315
R639	315-0682-00	XB020000		RES., FXD, CMPSN:6.8K OHM, 5%, 0.25W	01121	CB6825
R640	315-0681-00	XB020000		RES., FXD, CMPSN:680 OHM, 5%, 0.25W	01121	CB6815
R641	315-0102-00			RES., FXD, CMPSN:1K OHM, 5%, 0.25W	01121	CB1025
R645	315-0102-00			RES., FXD, CMPSN:1K OHM, 5%, 0.25W	01121	CB1025
R647	301-0102-00			RES., FXD, CMPSN:1K OHM, 5%, 0.50W	01121	EB1025
R649	315-0241-00	B010100	B059999	RES., FXD, CMPSN:240 OHM, 5%, 0.25W	01121	CB2415
R649	315-0181-00	B060000		RES., FXD, CMPSN:180 OHM, 5%, 0.25W	01121	CB1815
R650	315-0271-00			RES., FXD, CMPSN:270 OHM, 5%, 0.25W	01121	CB2715
R651	315-0301-00			RES., FXD, CMPSN:300 OHM, 5%, 0.25W	01121	CB3015
R654	315-0101-00			RES., FXD, CMPSN:100 OHM, 5%, 0.25W	01121	CB1015
R656	321-0066-00			RES., FXD, FILM:47.5 OHM, 1%, 0.125W	91637	MFF1816G47R50F
R661	301-0122-00			RES., FXD, CMPSN:1.2K OHM, 5%, 0.50W	01121	EB1225
R663	315-0241-00	B010100	B059999	RES., FXD, CMPSN:240 OHM, 5%, 0.25W	01121	CB2415
R663	315-0181-00	B060000		RES., FXD, CMPSN:180 OHM, 5%, 0.25W	01121	CB1815
R664	315-0271-00			RES., FXD, CMPSN:270 OHM, 5%, 0.25W	01121	CB2715
R666	315-0101-00			RES., FXD, CMPSN:100 OHM, 5%, 0.25W	01121	CB1015
R668	315-0821-00			RES., FXD, CMPSN:820 OHM, 5%, 0.25W	01121	CB8215
R669	315-0102-00			RES., FXD, CMPSN:1K OHM, 5%, 0.25W	01121	CB1025
R671	315-0222-00			RES., FXD, CMPSN:2.2K OHM, 5%, 0.25W	01121	CB2225
R672	315-0510-00			RES., FXD, CMPSN:51 OHM, 5%, 0.25W	01121	CB5105
R681	315-0680-00			RES., FXD, CMPSN:68 OHM, 5%, 0.25W	01121	CB6805
R682	315-0331-00			RES., FXD, CMPSN:330 OHM, 5%, 0.25W	01121	CB3315
R683	315-0302-00			RES., FXD, CMPSN:3K OHM, 5%, 0.25W	01121	CB3025
R685	315-0362-00			RES., FXD, CMPSN:3.6K OHM, 5%, 0.25W	01121	CB3625
R686	315-0152-00			RES., FXD, CMPSN:1.5K OHM, 5%, 0.25W	01121	CB1525
R688	315-0102-00			RES., FXD, CMPSN:1K OHM, 5%, 0.25W	01121	CB1025
R689	315-0332-00			RES., FXD, CMPSN:3.3K OHM, 5%, 0.25W	01121	CB3325
R700	311-0959-00			RES., VAR, WW:10K OHM, 5%, 1.5W	71590	BA165-007
R702	315-0103-00			RES., FXD, CMPSN:10K OHM, 5%, 0.25W	01121	CB1035
R704	321-0402-00			RES., FXD, FILM:150K OHM, 1%, 0.125W	91637	MFF1816G15002F
R706	315-0302-00			RES., FXD, CMPSN:3K OHM, 5%, 0.25W	01121	CB3025
R708	315-0272-00			RES., FXD, CMPSN:2.7K OHM, 5%, 0.25W	01121	CB2725
R709	321-0322-00			RES., FXD, FILM:22.1K OHM, 1%, 0.125W	91637	MFF1816G22101F
R711	315-0152-00	B010100	B039999	RES., FXD, CMPSN:1.5K OHM, 5%, 0.25W	01121	CB1525
R711	315-0102-00	B040000		RES., FXD, CMPSN:1K OHM, 5%, 0.25W	01121	CB1025
R712	321-0352-00			RES., FXD, FILM:45.3K OHM, 1%, 0.125W	91637	MFF1816G45301F
R713	321-0235-00			RES., FXD, FILM:2.74K OHM, 1%, 0.125W	91637	MFF1816G27400F
R715	321-0235-00			RES., FXD, FILM:2.74K OHM, 1%, 0.125W	91637	MFF1816G27400F

Replaceable Electrical Parts—7D11

Ckt No.	Tektronix Part No.	Serial/Model No. Eff	Dscont	Name & Description	Mfr Code	Mfr Part Number
R716	321-0352-00			RES., FXD, FILM:45.3K OHM, 1%, 0.125W	91637	MFF1816G45301F
R718	315-0241-00			RES., FXD, CMPSN:240 OHM, 5%, 0.25W	01121	CB2415
R720	321-0260-00			RES., FXD, FILM:4.99K OHM, 1%, 0.125W	91637	MFF1816G49900F
R721	315-0272-00			RES., FXD, CMPSN:2.7K OHM, 5%, 0.25W	01121	CB2725
R723	315-0104-00			RES., FXD, CMPSN:100K OHM, 5%, 0.25W	01121	CB1045
R725	315-0122-00			RES., FXD, CMPSN:1.2K OHM, 5%, 0.25W	01121	CB1225
R727	315-0153-00			RES., FXD, CMPSN:15K OHM, 5%, 0.25W	01121	CB1535
R729	315-0102-00			RES., FXD, CMPSN:1K OHM, 5%, 0.25W	01121	CB1025
R734	315-0682-00			RES., FXD, CMPSN:6.8K OHM, 5%, 0.25W	01121	CB6825
R735	315-0153-00			RES., FXD, CMPSN:15K OHM, 5%, 0.25W	01121	CB1535
R737	315-0101-00			RES., FXD, CMPSN:100 OHM, 5%, 0.25W	01121	CB1015
R741	315-0202-00			RES., FXD, CMPSN:2K OHM, 5%, 0.25W	01121	CB2025
R744	315-0152-00			RES., FXD, CMPSN:1.5K OHM, 5%, 0.25W	01121	CB1525
R751	315-0304-00			RES., FXD, CMPSN:300K OHM, 5%, 0.25W	01121	CB3045
R752	315-0222-00	XB020000		RES., FXD, CMPSN:2.2K OHM, 5%, 0.25W	01121	CB2225
R753	315-0431-00			RES., FXD, CMPSN:430 OHM, 5%, 0.25W	01121	CB4315
R754	315-0221-00	XB030000		RES., FXD, CMPSN:220 OHM, 5%, 0.25W	01121	CB2215
R756	315-0472-00			RES., FXD, CMPSN:4.7K OHM, 5%, 0.25W	01121	CB4725
R757	315-0103-00			RES., FXD, CMPSN:10K OHM, 5%, 0.25W	01121	CB1035
R798	315-0101-00			RES., FXD, CMPSN:100 OHM, 5%, 0.25W	01121	CB1015
R833	315-0431-00			RES., FXD, CMPSN:430 OHM, 5%, 0.25W	01121	CB4315
R836	315-0360-00	B010100	B019999	RES., FXD, CMPSN:36 OHM, 5%, 0.25W	01121	CB3605
R836	315-0300-00	B020000		RES., FXD, CMPSN:30 OHM, 5%, 0.25W	01121	CB3005
R837	315-0331-00			RES., FXD, CMPSN:330 OHM, 5%, 0.25W	01121	CB3315
R838	315-0181-00			RES., FXD, CMPSN:180 OHM, 5%, 0.25W	01121	CB1815
R900	315-0302-00			RES., FXD, CMPSN:3K OHM, 5%, 0.25W	01121	CB3025
R904	315-0302-00			RES., FXD, CMPSN:3K OHM, 5%, 0.25W	01121	CB3025
R908	315-0302-00			RES., FXD, CMPSN:3K OHM, 5%, 0.25W	01121	CB3025
R912	315-0302-00			RES., FXD, CMPSN:3K OHM, 5%, 0.25W	01121	CB3025
R916	315-0302-00			RES., FXD, CMPSN:3K OHM, 5%, 0.25W	01121	CB3025
R920	315-0302-00			RES., FXD, CMPSN:3K OHM, 5%, 0.25W	01121	CB3025
R924	315-0302-00			RES., FXD, CMPSN:3K OHM, 5%, 0.25W	01121	CB3025
R928	315-0302-00			RES., FXD, CMPSN:3K OHM, 5%, 0.25W	01121	CB3025
R929	315-0153-00	XB100000		RES., FXD, CMPSN:15K OHM, 5%, 0.25W	01121	CB1535
R930	315-0272-00			RES., FXD, CMPSN:2.7K OHM, 5%, 0.25W	01121	CB2725
R932	315-0272-00			RES., FXD, CMPSN:2.7K OHM, 5%, 0.25W	01121	CB2725
R934	315-0272-00			RES., FXD, CMPSN:2.7K OHM, 5%, 0.25W	01121	CB2725
R936	315-0272-00			RES., FXD, CMPSN:2.7K OHM, 5%, 0.25W	01121	CB2725
R943	315-0221-00			RES., FXD, CMPSN:220 OHM, 5%, 0.25W	01121	CB2215
R952	315-0222-00			RES., FXD, CMPSN:2.2K OHM, 5%, 0.25W	01121	CB2225
R960	321-0398-00			RES., FXD, FILM:137K OHM, 1%, 0.125W	91637	MFF1816G13702F
R961	321-0369-00			RES., FXD, FILM:68.1K OHM, 1%, 0.125W	91637	MFF1816G68101F
R962	321-0690-00			RES., FXD, FILM:34K OHM, 1%, 0.125W	91637	MFF1816G34001D
R963	321-0673-00			RES., FXD, FILM:17K OHM, 0.5%, 0.125W	91637	MFF1816D17001D
R965	321-0604-00			RES., FXD, FILM:30K OHM, 0.25%, 0.125W	91637	MFF1816D30001C
R969	321-1289-03			RES., FXD, FILM:10.1K OHM, 0.25%, 0.125W	91637	MFF1816D10101C
R971	315-0222-00			RES., FXD, CMPSN:2.2K OHM, 5%, 0.25W	01121	CB2225
R974	321-0289-00			RES., FXD, FILM:10K OHM, 1%, 0.125W	91637	MFF1816G10001F
R976	315-0222-00			RES., FXD, CMPSN:2.2K OHM, 5%, 0.25W	01121	CB2225
R977	315-0153-00			RES., FXD, CMPSN:15K OHM, 5%, 0.25W	01121	CB1535
R979	315-0153-00			RES., FXD, CMPSN:15K OHM, 5%, 0.25W	01121	CB1535
R984	315-0101-00	XB070000		RES., FXD, CMPSN:100 OHM, 5%, 0.25W	01121	CB1015
R989	321-0352-00			RES., FXD, FILM:45.3K OHM, 1%, 0.125W	91637	MFF1816G45301F
R990	321-0398-00			RES., FXD, FILM:137K OHM, 1%, 0.125W	91637	MFF1816G13702F

Ckt No.	Tektronix Part No.	Serial/Model No. Eff	Dscont	Name & Description	Mfr Code	Mfr Part Number
R992	321-0340-00			RES.,FXD,FILM:34K OHM,1%,0.125W	91637	MF1816G34001F
R993	321-0398-00			RES.,FXD,FILM:137K OHM,1%,0.125W	91637	MF1816G13702F
R994	321-0340-00			RES.,FXD,FILM:34K OHM,1%,0.125W	91637	MF1816G34001F
R995	321-0323-00			RES.,FXD,FILM:22.6K OHM,1%,0.125W	91637	MF1816G22601F
R997	321-0331-00			RES.,FXD,FILM:27.4K OHM,1%,0.125W	91637	MF1816G27401F
R998	321-0398-00			RES.,FXD,FILM:137K OHM,1%,0.125W	91637	MF1816G13702F
R1009	315-0150-00			RES.,FXD,CMPSN:15 OHM,5%,0.25W	01121	CB1505
R1011	307-0106-00			RES.,FXD,CMPSN:4.7 OHM,5%,0.25W	01121	CB47G5
R1013	315-0100-00			RES.,FXD,CMPSN:10 OHM,5%,0.25W	01121	CB1005
R1015	307-0106-00			RES.,FXD,CMPSN:4.7 OHM,5%,0.25W	01121	CB47G5
R1024	315-0561-00			RES.,FXD,CMPSN:560 OHM,5%,0.25W	01121	CB5615
R1026	315-0122-00			RES.,FXD,CMPSN:1.2K OHM,5%,0.25W	01121	CB1225
R1028	315-0681-00			RES.,FXD,CMPSN:680 OHM,5%,0.25W	01121	CB6815
R1030	315-0303-00			RES.,FXD,CMPSN:30K OHM,5%,0.25W	01121	CB3035
R1031	315-0471-00			RES.,FXD,CMPSN:470 OHM,5%,0.25W	01121	CB4715
R1033	315-0101-00			RES.,FXD,CMPSN:100 OHM,5%,0.25W	01121	CB1015
R1034	315-0223-00			RES.,FXD,CMPSN:22K OHM,5%,0.25W	01121	CB2235
R1036	315-0270-00			RES.,FXD,CMPSN:27 OHM,5%,0.25W	01121	CB2705
R1041	315-0100-00			RES.,FXD,CMPSN:10 OHM,5%,0.25W	01121	CB1005
R1045	315-0680-00			RES.,FXD,CMPSN:68 OHM,5%,0.25W	01121	CB6805
R1069	315-0511-00			RES.,FXD,CMPSN:510 OHM,5%,0.25W	01121	CB5115
R1074	315-0270-00			RES.,FXD,CMPSN:27 OHM,5%,0.25W	01121	CB2705
S5 ¹	670-1221-02			PUSH BUTTON--TRIGGER SOURCE	80009	670-1221-02
S95 ¹	670-1222-02			PUSH BUTTON--TRIGGER COUPLING	80009	670-1222-02
S111 ²						TRIGGER SLOPE
S210 ¹	670-2149-00			PUSH BUTTON--COUNT MODE	80009	670-2149-00
S444	260-0723-00			SWITCH,SLIDE:DPDT,0.5A,125VAC	79727	GF126-0028
S555 ¹	670-2148-00			PUSH BUTTON--B SWEEP DELAY MODE	80009	670-2148-00
S615 ³				EVENTS START TRIGGER SLOPE		
S669	260-0723-00			SWITCH,SLIDE:DPDT,0.5A,125VAC	79727	GF126-0028
S754	260-0735-00	XB030000		SWITCH,PUSH:SPST	81073	39-1
T579	120-0444-00			XFMR,TOROID:5 TURNS,BIFILAR	80009	120-0444-00
T1038	120-0784-00			TRANSFORMER,PLS:POT CORE,SW REGULATOR	80009	120-0784-00
U60	155-0022-00			MICROCIRCUIT,DI:A AND B LOGIC ML CHAN SW	80009	155-0022-00
U205	156-0079-00			MICROCIRCUIT,DI:DECADE COUNTER,TTL	07263	9390PC
U230	156-0124-00			MICROCIRCUIT,DI:SGL FREQ/PHASE DETECTOR	80009	156-0124-00
U240	156-0105-00			MICROCIRCUIT,LI:OPERATIONAL AMPLIFIER	27014	LM301AN
U327	156-0100-00			MICROCIRCUIT,DI:J-K EDGE TRIGGERED FF	01295	SN74H102N
U329	156-0079-00			MICROCIRCUIT,DI:DECADE COUNTER,TTL	07263	9390PC
U444A,B	156-0118-00			MICROCIRCUIT,DI:J-K MASTER-SLAVE FLIP-FLOP	01295	SN74S112N
U543A,B	156-0118-00			MICROCIRCUIT,DI:J-K MASTER-SLAVE FLIP-FLOP	01295	SN74S112N
U586	156-0043-00	B010100	B019999	MICROCIRCUIT,DI:QUAD 2-INPUT POS NOR GATE	80009	156-0043-00
U586	156-0043-02	B020000	B029999	MICROCIRCUIT,DI:2-INPUT NOR GATE	80009	156-0043-02
U586	156-0043-00	B030000		MICROCIRCUIT,DI:QUAD 2-INPUT POS NOR GATE	80009	156-0043-00
U589	156-0172-00			MICROCIRCUIT,DI:DUAL RETRIG MONOSTABLE MV	80009	156-0172-00
U598	156-0172-00			MICROCIRCUIT,DI:DUAL RETRIG MONOSTABLE MV	80009	156-0172-00
U640	156-0180-00			MICROCIRCUIT,DI:QUAD 2-INPUT NAND GATE	01295	SN74S00N
U747	156-0030-00			MICROCIRCUIT,DI:QUAD 2-INPUT POS NAND GATE	01295	SN7400N
U749	156-0058-00			MICROCIRCUIT,DI:HEX.INVERTER	01295	SN7404N
U760	156-0245-00			MICROCIRCUIT,DI:DECADE CNTR W/UP DOWN CLK	01295	SN74L192N
U762	156-0245-00			MICROCIRCUIT,DI:DECADE CNTR W/UP DOWN CLK	01295	SN74L192N
U764	156-0245-00			MICROCIRCUIT,DI:DECADE CNTR W/UP DOWN CLK	01295	SN74L192N

¹See Mechanical Parts List for replacement parts.

²Furnished as a unit with R111.

³Furnished as a unit with R615.

Replaceable Electrical Parts—7D11

Ckt No.	Tektronix Part No.	Serial/Model No. Eff	Dscont	Name & Description	Mfr Code	Mfr Part Number
U766	156-0245-00			MICROCIRCUIT,DI:DECADE CNTR W/UP DOWN CLK	01295	SN74L192N
U768	156-0245-00			MICROCIRCUIT,DI:DECADE CNTR W/UP DOWN CLK	01295	SN74L192N
U770	156-0245-00			MICROCIRCUIT,DI:DECADE CNTR W/UP DOWN CLK	01295	SN74L192N
U772	156-0245-00			MICROCIRCUIT,DI:DECADE CNTR W/UP DOWN CLK	01295	SN74L192N
U780	156-0129-00			MICROCIRCUIT,DI:QUAD 2-INPUT GATE	01295	SN7408N
U782	156-0129-00			MICROCIRCUIT,DI:QUAD 2-INPUT GATE	01295	SN7408N
U784	156-0129-00			MICROCIRCUIT,DI:QUAD 2-INPUT GATE	01295	SN7408N
U786	156-0129-00			MICROCIRCUIT,DI:QUAD 2-INPUT GATE	01295	SN7408N
U788	156-0129-00			MICROCIRCUIT,DI:QUAD 2-INPUT GATE	01295	SN7408N
U790	156-0129-00			MICROCIRCUIT,DI:QUAD 2-INPUT GATE	01295	SN7408N
U792	156-0129-00			MICROCIRCUIT,DI:QUAD 2-INPUT GATE	01295	SN7408N
U800	156-0097-00			MICROCIRCUIT,DI:DIV BY 2 AND 5 RIPPLE CNTR	80009	156-0097-00
U802	156-0097-00			MICROCIRCUIT,DI:DIV BY 2 AND 5 RIPPLE CNTR	80009	156-0097-00
U804	156-0091-00			MICROCIRCUIT,DI:DIV BY 2 AND 5 RIPPLE CNTR	80009	156-0091-00
U806	156-0091-00			MICROCIRCUIT,DI:DIV BY 2 AND 5 RIPPLE CNTR	80009	156-0091-00
U808	156-0091-00			MICROCIRCUIT,DI:DIV BY 2 AND 5 RIPPLE CNTR	80009	156-0091-00
U810	156-0091-00			MICROCIRCUIT,DI:DIV BY 2 AND 5 RIPPLE CNTR	80009	156-0091-00
U812	156-0091-00			MICROCIRCUIT,DI:DIV BY 2 AND 5 RIPPLE CNTR	80009	156-0091-00
U820	156-0035-00			MICROCIRCUIT,DI:SGL 8-INPUT POS NAND GATE	80009	156-0035-00
U825	156-0035-00			MICROCIRCUIT,DI:SGL 8-INPUT POS NAND GATE	80009	156-0035-00
U902	156-0057-00			MICROCIRCUIT,DI:QUAD 2-INPUT NAND GATE	07263	7401PC
U906	156-0057-00			MICROCIRCUIT,DI:QUAD 2-INPUT NAND GATE	07263	7401PC
U910	156-0057-00			MICROCIRCUIT,DI:QUAD 2-INPUT NAND GATE	07263	7401PC
U914	156-0057-00			MICROCIRCUIT,DI:QUAD 2-INPUT NAND GATE	07263	7401PC
U918	156-0057-00			MICROCIRCUIT,DI:QUAD 2-INPUT NAND GATE	07263	7401PC
U922	156-0057-00			MICROCIRCUIT,DI:QUAD 2-INPUT NAND GATE	07263	7401PC
U926	156-0057-00			MICROCIRCUIT,DI:QUAD 2-INPUT NAND GATE	07263	7401PC
U940	156-0043-00			MICROCIRCUIT,DI:QUAD 2-INPUT POS NOR GATE	80009	156-0043-00
U946	156-0035-00			MICROCIRCUIT,DI:SGL 8-INPUT POS NAND GATE	80009	156-0035-00
U948	156-0035-00			MICROCIRCUIT,DI:SGL 8-INPUT POS NAND GATE	80009	156-0035-00
U952	156-0047-00			MICROCIRCUIT,DI:TPL 3-INPUT POS NAND GATE	80009	156-0047-00
U974	156-0259-00			MICROCIRCUIT,LI:5 TRANSISTOR ARRAY	80009	156-0259-00
U984	156-0259-00			MICROCIRCUIT,LI:5 TRANSISTOR ARRAY	80009	156-0259-00
VR114	152-0226-00			SEMICONV DEVICE:ZENER,0.4W,5.1V,5%	81483	69-6584
VR254	152-0166-00			SEMICONV DEVICE:ZENER,0.4W,6.2V,5%	81483	69-9035
VR263	152-0166-00			SEMICONV DEVICE:ZENER,0.4W,6.2V,5%	81483	69-9035
VR281B	153-0049-00			SEMICONV DVC SE:MTCHD WITHIN 20MV AT 2.5MA	80009	153-0049-00
VR287B						
VR293B						
VR299B						
VR305B						
VR311B						
VR380	152-0166-00			SEMICONV DEVICE:ZENER,0.4W,6.2V,5%	81483	69-9035
VR395A	153-0049-00			SEMICONV DVC SE:MTCHD WITHIN 20MV AT 2.5MA	80009	153-0049-00
VR403A						
VR408A						
VR413A						
VR418A						
VR423A						
VR626	152-0127-00	XB040000		SEMICONV DEVICE:ZENER,0.4W,7.5V,5%	04713	1N958B
VR734	152-0279-00			SEMICONV DEVICE:ZENER,0.4W,5.1V,5%	80009	152-0279-00
Y200	119-0262-00			OSCILLATOR,RF:XTAL CONTROLLED,5 MHZ ADJ	13571	ER05-600-TK-9

DIAGRAMS AND CIRCUIT BOARD ILLUSTRATIONS

Symbols and Reference Designators

Electrical components shown on the diagrams are in the following units unless noted otherwise:

- Capacitors = Values one or greater are in picofarads (pF).
Values less than one are in microfarads (μ F).
- Resistors = Ohms (Ω).

Symbols used on the diagrams are based on USA Standard Y32.2-1967.

Logic symbology is based on MIL-STD-806B in terms of positive logic. Logic symbols depict the logic function performed and may differ from the manufacturer's data.

The following prefix letters are used as reference designators to identify components or assemblies on the diagrams.

A Assembly, separable or repairable (circuit board, etc.)	H Heat dissipating device (heat sink, heat radiator, etc.)	RT Thermistor
AT Attenuator, fixed or variable	HR Heater	S Switch
B Motor	HY Hybrid circuit	T Transformer
BT Battery	J Connector, stationary portion	TC Thermocouple
C Capacitor, fixed or variable	K Relay	TP Test point
CB Circuit breaker	L Inductor, fixed or variable	U Assembly, inseparable or non-repairable (integrated circuit, etc.)
CR Diode, signal or rectifier	LR Inductor/resistor combination	V Electron tube
DL Delay line	M Meter	VR Voltage regulator (zener diode, etc.)
DS Indicating device (lamp)	P Connector, movable portion	Y Crystal
E Spark Gap	Q Transistor or silicon-controlled rectifier	Z Phase shifter
F Fuse	R Resistor, fixed or variable	
FL Filter		

The following special symbols are used on the diagrams:

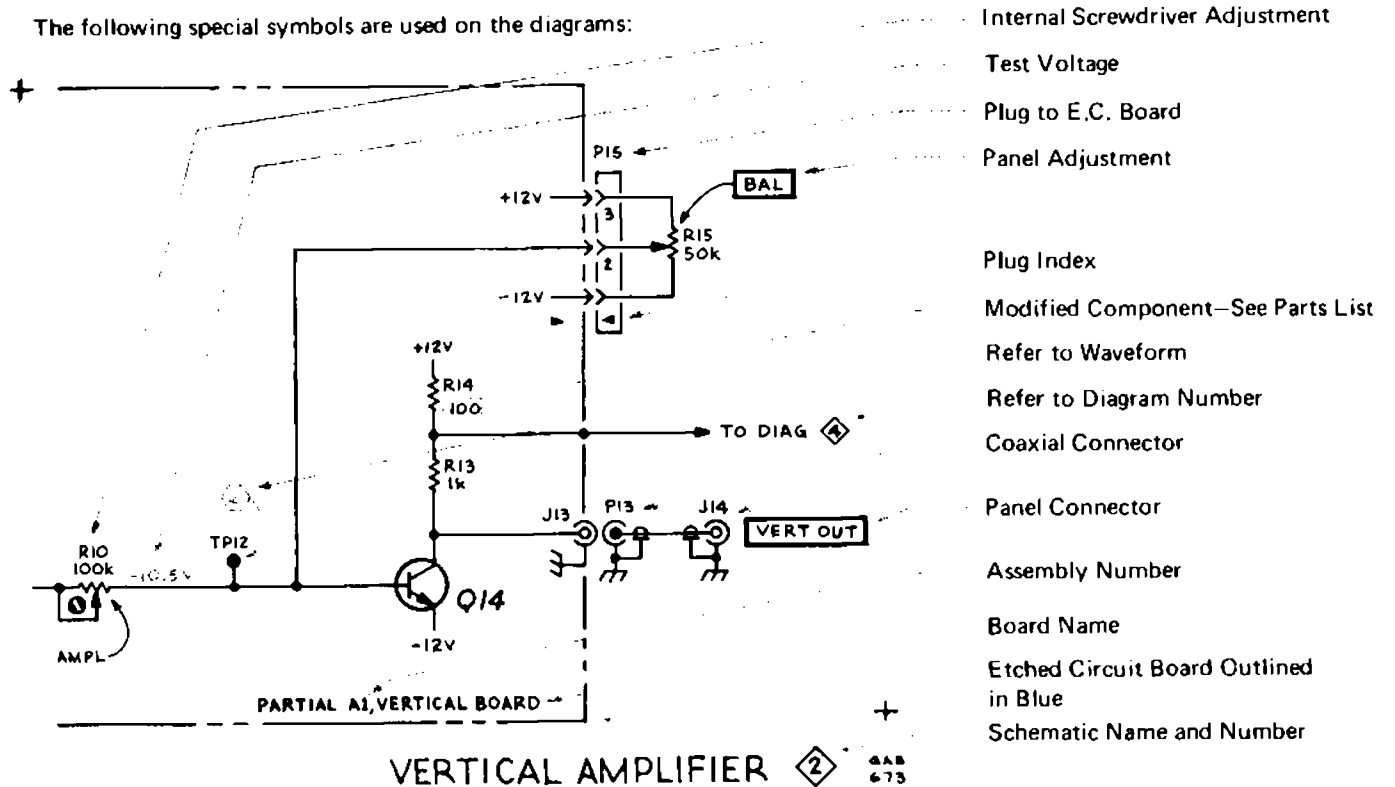

Internal Screwdriver Adjustment

Test Voltage

Plug to E.C. Board

Panel Adjustment

Plug Index

Modified Component—See Parts List

Refer to Waveform

Refer to Diagram Number

Coaxial Connector

Panel Connector

Assembly Number

Board Name

Etched Circuit Board Outlined in Blue

Schematic Name and Number

VOLTAGES AND WAVEFORMS

The voltages and waveforms shown on this diagram are obtained by using the recommended test equipment and test set-ups listed below.

RECOMMENDED TEST EQUIPMENT

ITEM	SPECIFICATIONS	RECOMMENDED TYPE
Oscilloscope	Frequency response DC to 64 MHz Deflection factor 5 mV to 5 V/Div Input impedance 10 M Ω , 20 pF Sweep rate 500 ns	Tektronix 7603 or 7613 equipped with 7A13 Differential Comparator to obtain DC offset and a 7B50 Time-Base Unit, or equivalent.
Probe	Fast rise 10X attenuation probe compatible with the vertical amplifier of the test oscilloscope.	Tektronix P6053A, or equivalent.
Voltmeter (Non-loading digital multimeter)	Input impedance 10 M Ω Range 0-500 V	Tektronix 7D13 Digital Multimeter (test oscilloscope must have readout system) or Fairchild Model 7050, or equivalent.
Extender	Required for extending the 7D11 from the mainframe when making waveform and voltage measurements.	Tektronix extender plug-in. Tektronix Part Number 067-0589-00 or Tektronix flexible extender, Tektronix Part Number 067-0616-00, or equivalent.
Time mark generator	1 μ second markers 10 μ second triggers 0.5 volt amplitude	Tektronix 2901, or equivalent.

VOLTAGE CONDITIONS

The 7D11 under test must be connected to a mainframe separate from the test oscilloscope. No signal is applied for voltage measurements. Voltmeter common is connected to chassis ground.

7D11 CONTROL SETTINGS

EVENTS START TRIGGER	
SLOPE	+
LEVEL	+
COUPLING	DC
SOURCE	INT
B SWEEP DELAY MODE	INDEPENDENT
COUNT MODE	EVENTS
FIND DELAY	0
DELAY TIME OR EVENTS	0000005

WAVEFORM CONDITIONS

Front panel controls are set the same as for voltage measurements. The time mark generator 10-microsecond triggers are applied to the 7D11 EVENTS START TRIG IN connector. Except where noted, the test oscilloscope is externally triggered from the 10-microsecond signal from the time mark generator.

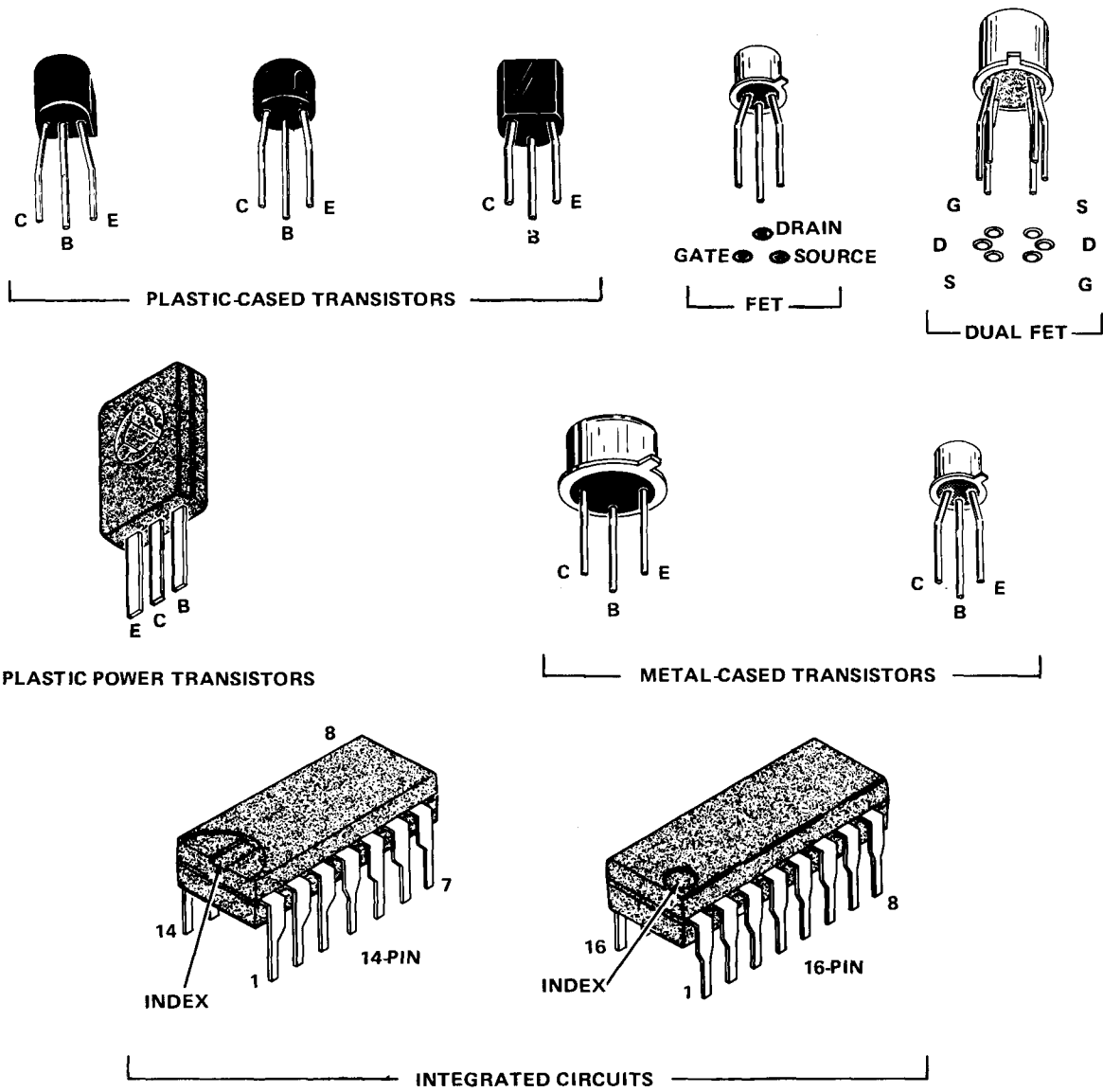
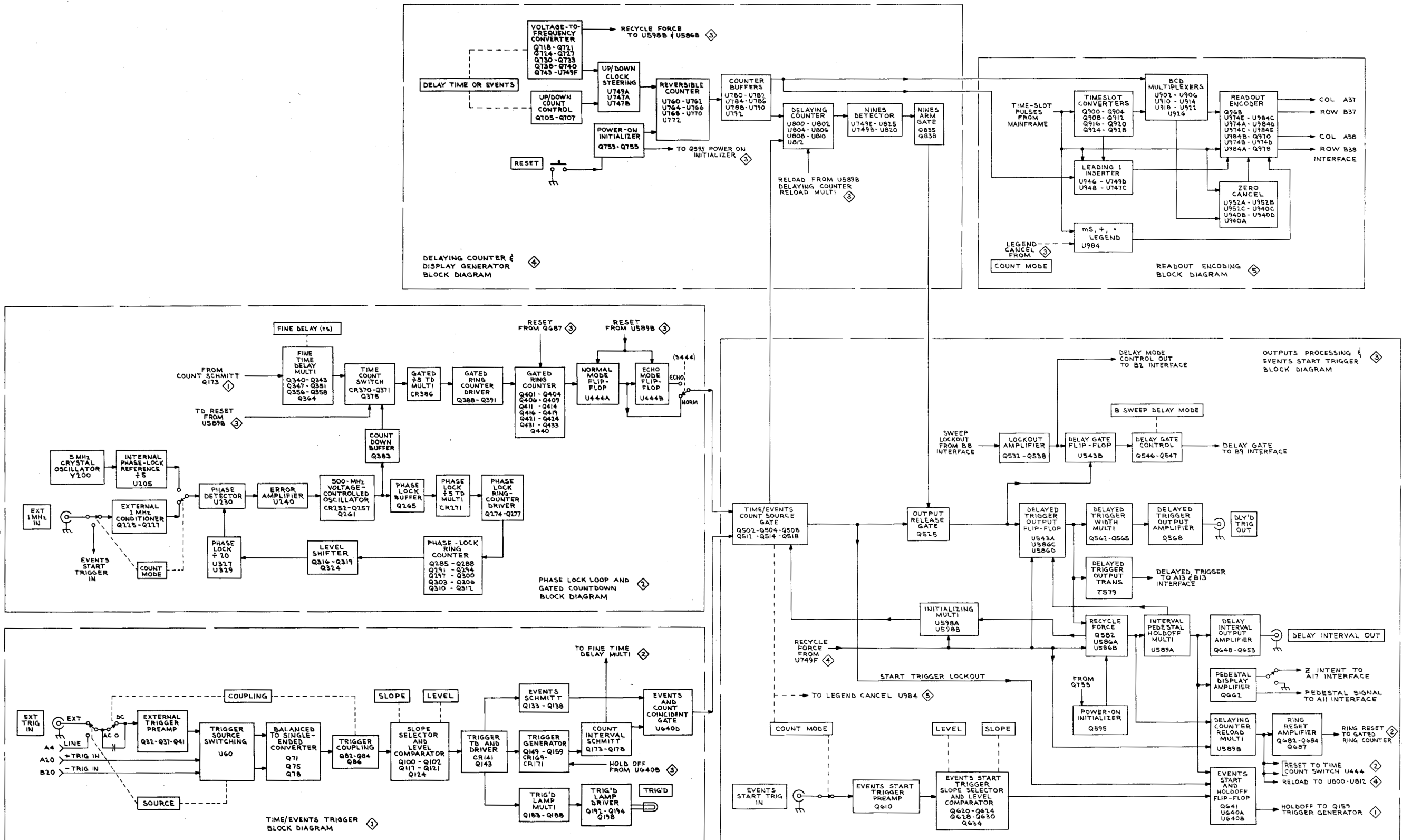
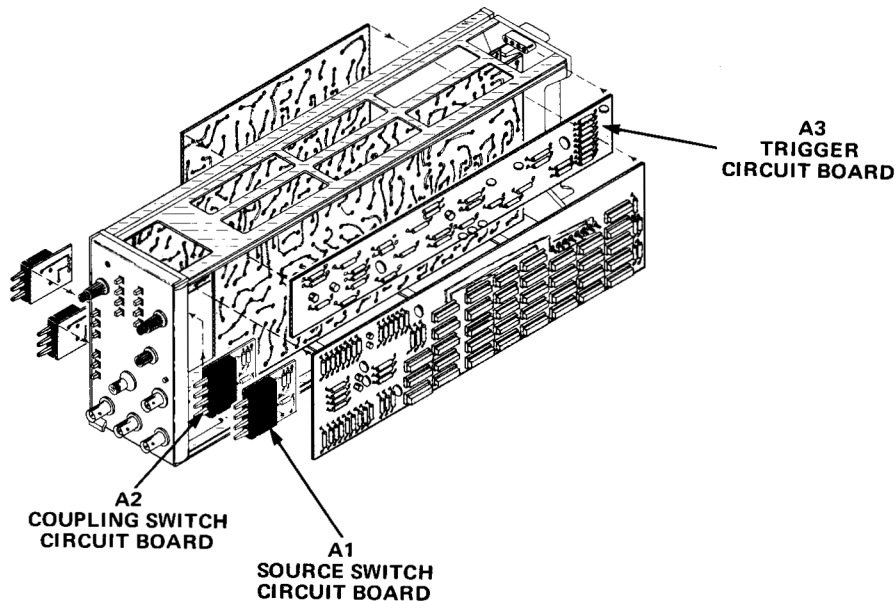

Fig. 6-1. Semiconductor lead configuration.





Grid locator for Fig. 6-5.

CKT NO	GRID LOC	CKT NO	GRID LOC	CKT NO	GRID LOC	CKT NO	GRID LOC	CKT NO	GRID LOC	CKT NO	GRID LOC
C24	1B	C182	4C	Q71	9B	R37	2B	R79	8B	R147	3B
C27	2C	C185	5B	Q75	8B	R38	2B	R80	8B	R148	3B
C32	1B	C188	4B	Q78	9B	R41	2B	R82	7C	R150	3B
C38	1B	C1014	2B	Q82	7C	R42	2B	R84	7B	R151	3B
C39	2B			Q84	7B	R44	2B	R86	7B	R152	3B
C41	2B	CR21	10B	Q86	7B	R46	10B	R89	7C	R154	4B
C62	9B	CR38	1C	Q100	7B	R48	8B	R101	7D	R156	3B
C67	9B	CR122	5B	Q102	6B	R49	9B	R103	6B	R157	3B
C75	8B	CR126	5B	Q117	6B	R50	9B	R104	3C	R160	3C
C82	7C	CR128	5B	Q121	7B	R52	8B	R107	6C	R161	4C
C83	8C	CR129	5B	Q124	5B	R55	9C	R108	6C	R162	3C
C84	8B	CR141	5B	Q143	4B	R57	10C	R109	6C	R166	5C
C86	7B	CR153	4B	Q149	3B	R60	10B	R113	7B	R168	4C
C87	7B	CR169	3C	Q159	3B	R61	10B	R115	6B	R170	4B
C88	7B	CR171	4B	Q183	4C	R63	10B	R118	6B	R182	5C
C102	7B	CR184	5B	Q188	4B	R64	10C	R119	6B	R184	5B
C106	6C			R21	10B	R66	10B	R120	6B	R185	4B
C119	6B	L140	5B	R22	10B	R68	10B	R122	5B	R186	4B
C122	5B			R24	2B	R69	10C	R124	5C	R188	4B
C126	6C	P20	1B	R26	2C	R71	8B	R126	5B	R189	4C
C145	5B			R27	2C	R73	9C	R128	5B	R1074	2C
C150	3B	Q21	11B	R28	1C	R75	8B	R130	5B		
C160	3C	Q32	2B	R30	1C	R76	8C	R141	5B	U60	9B
C162	2C	Q37	2B	R32	1B	R77	8B	R143	4B		
C166	5C	Q41	2B	R35	2C	R78	8B	R145	5C	VR114	6B

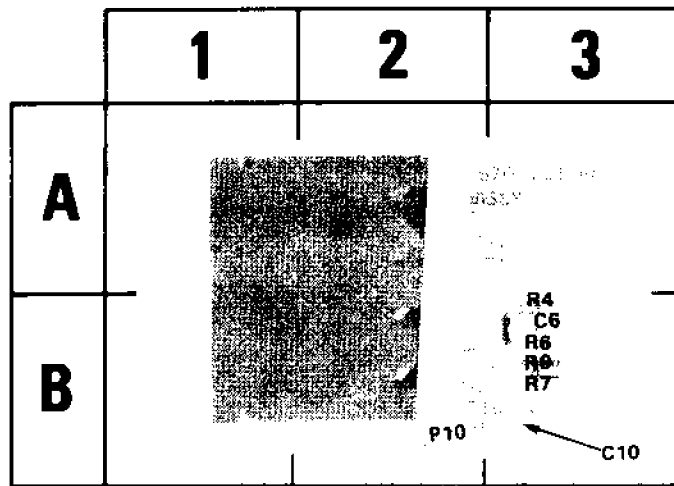

Fig. 6-3. A1—Source switch.

Ⓐ

Grid locator for Fig. 6-3 and 6-4.

CKT NO	GRID LOC
C6	3B
C10	3B
C96	1A
P10	2B
R4	3A
R6	3B
R7	3B
R9	3B
R92	1A
R96	1A

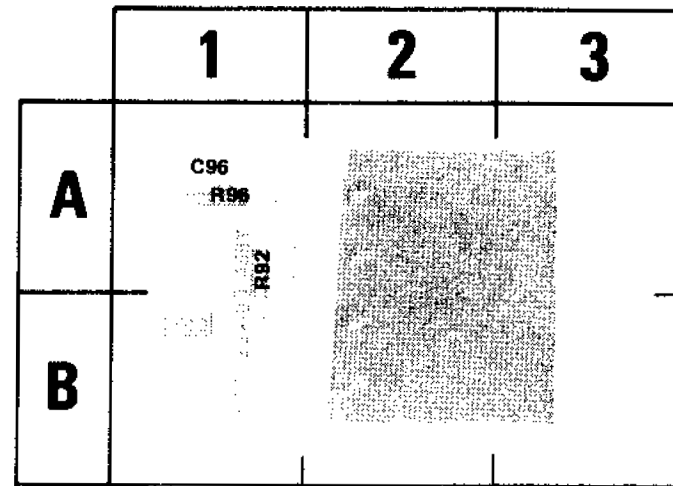

Fig. 6-4. A2—Coupling switch.

Ⓐ

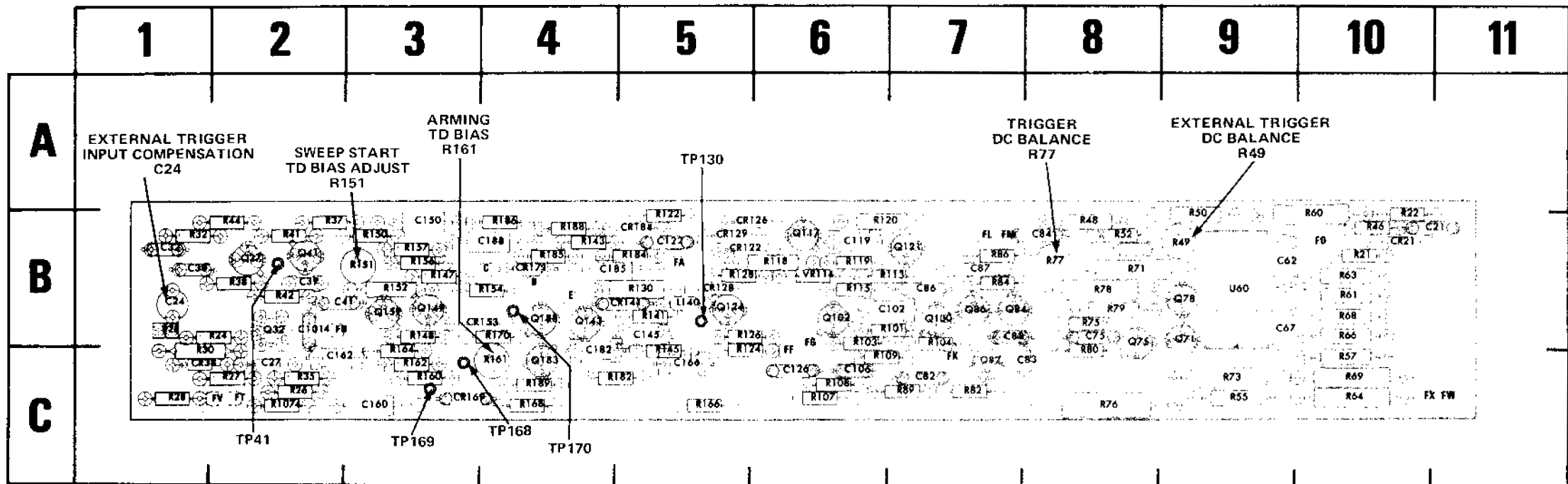
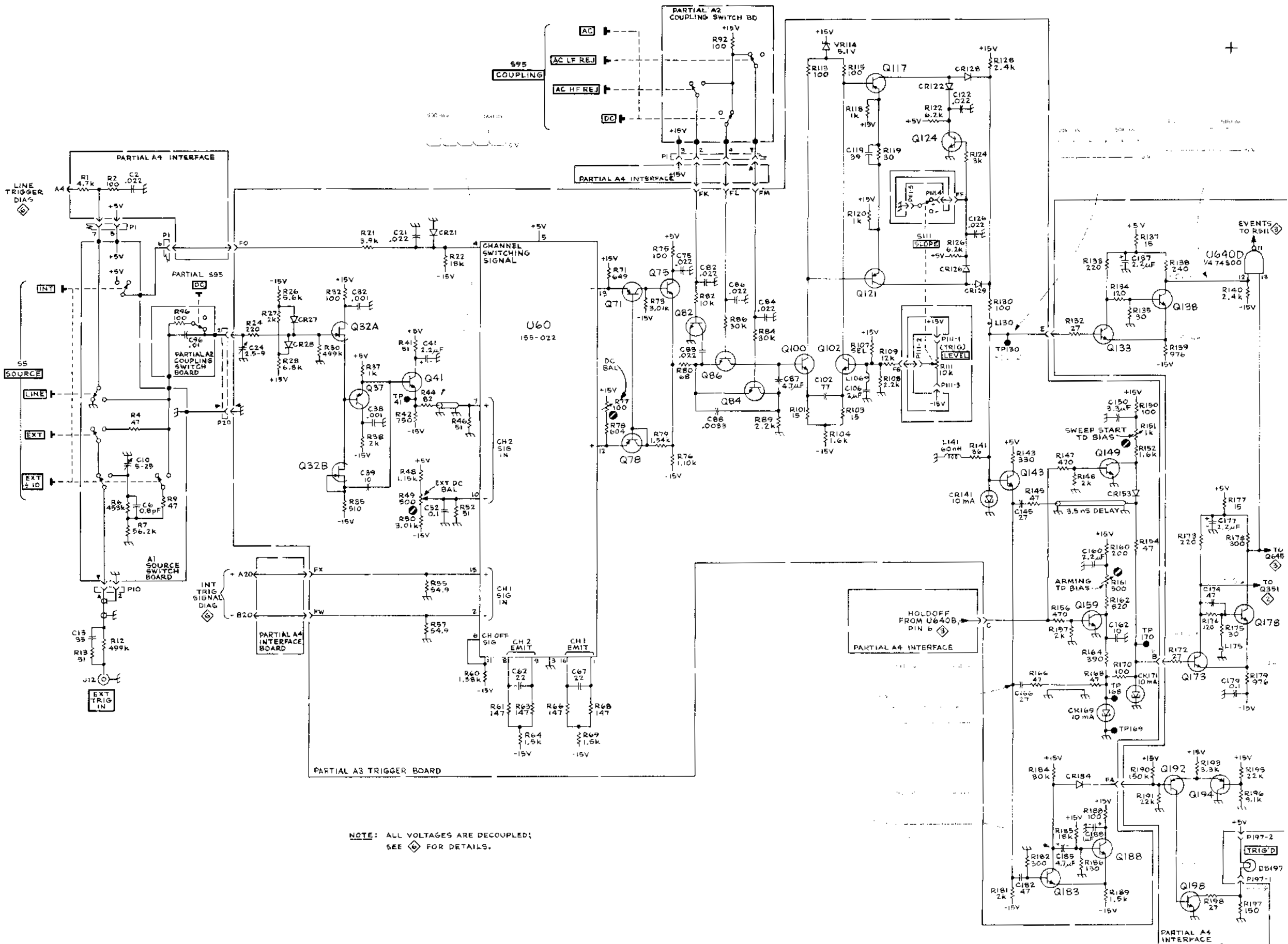

Fig. 6-5. A3—Time/events trigger circuit board.



NOTE: ALL VOLTAGES ARE DECOUPLED;
SEE [Symbol] FOR DETAILS.

7D11 Service

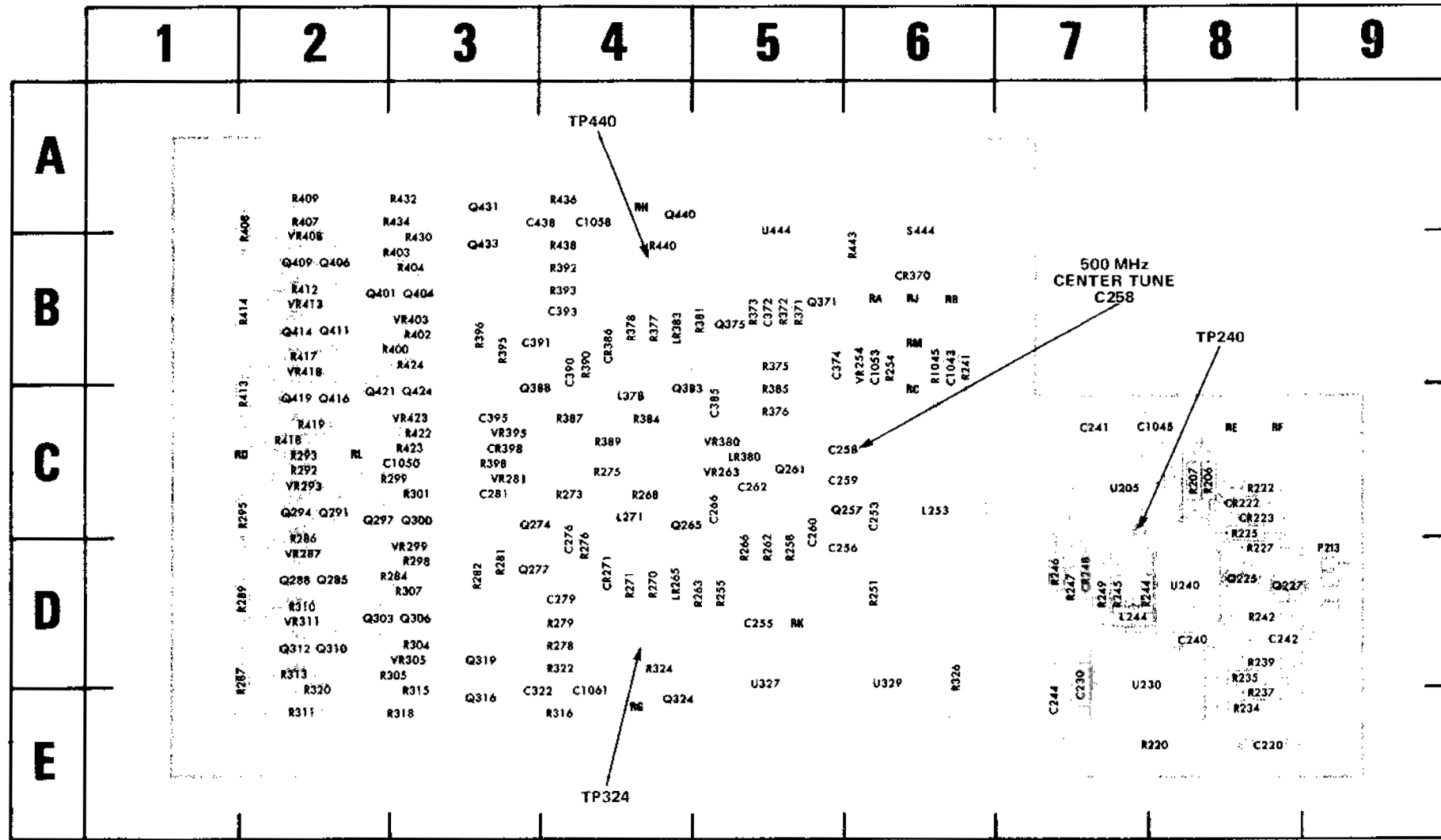
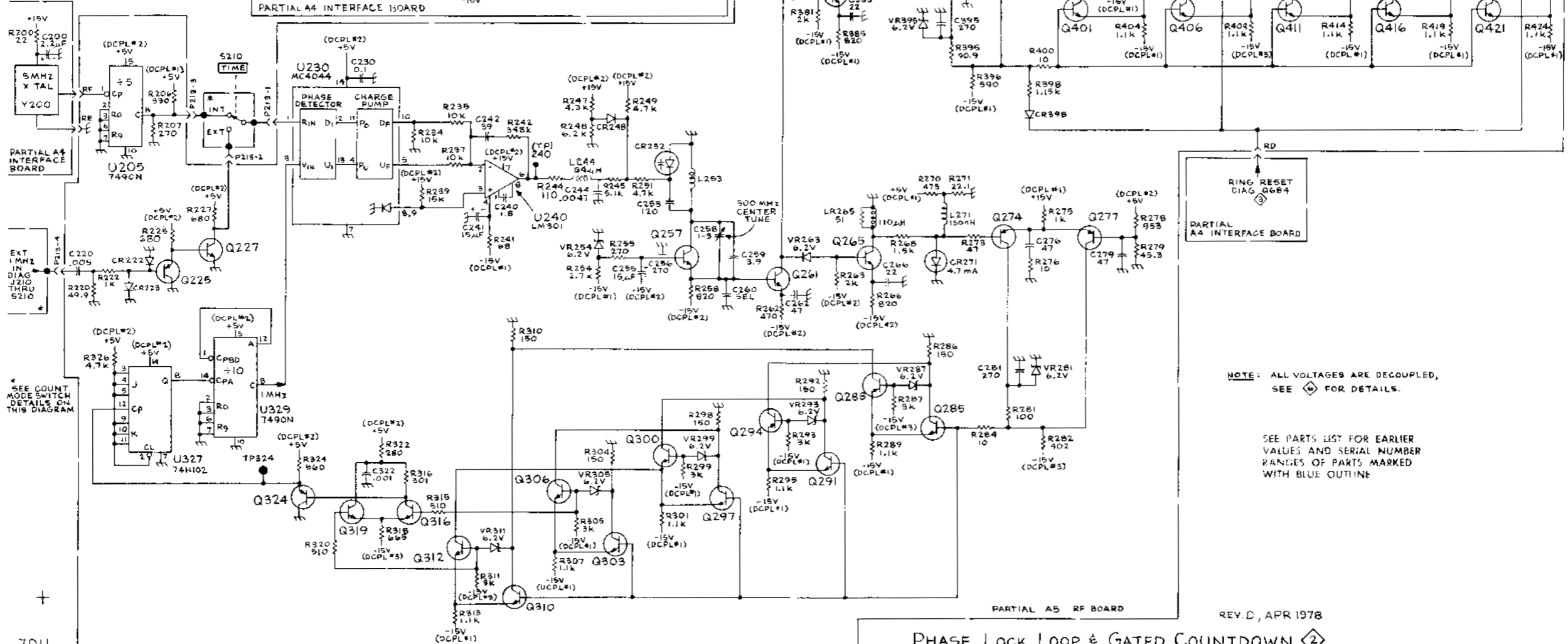
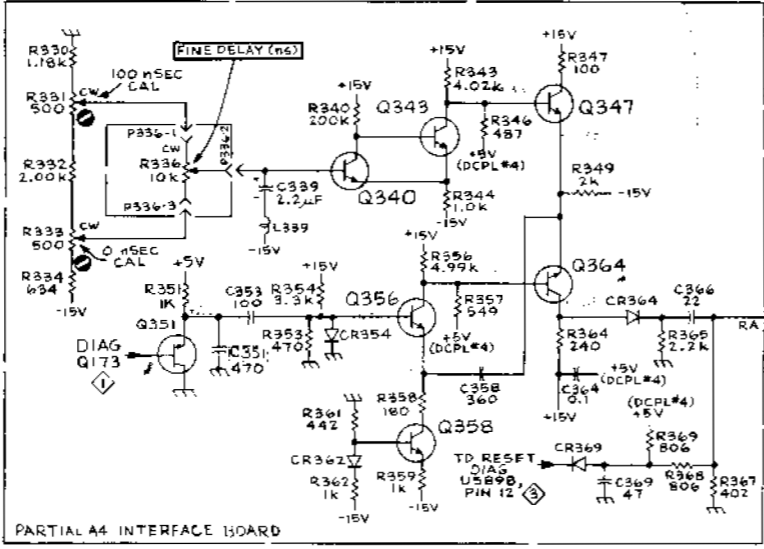
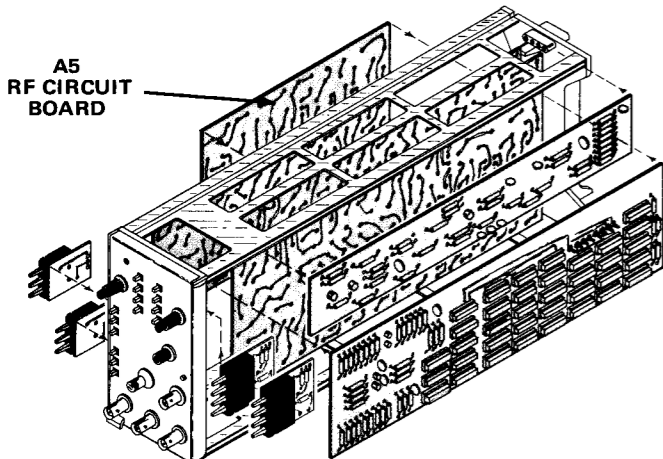
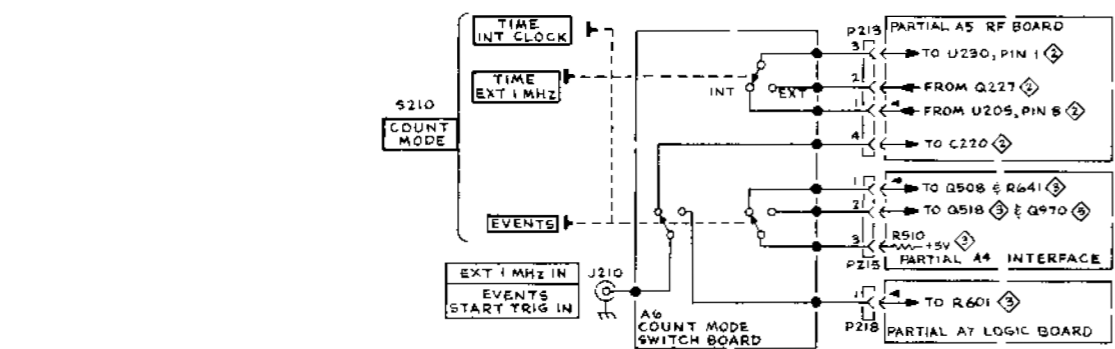

Fig. 6-6. A5-RF circuit board.

CKT NO	GRID LOC	CKT NO	GRID LOC	CKT NO	GRID LOC	CKT NO	GRID LOC
C220	8E	Q257	5C	R255	5D	R396	3B
C230	7D	Q261	5C	R258	5D	R398	3C
C240	8D	Q265	4C	R262	5D	R400	3B
C241	7C	Q274	3C	R263	5D	R402	3B
C242	8D	Q277	3D	R266	5D	R403	3B
C244	7E	Q285	2D	R268	4C	R404	3B
C253	6C	Q288	2D	R270	4D	R407	2A
C255	5D	Q291	2C	R271	4D	R408	2A
C256	5D	Q294	2C	R273	4C	R409	2A
C258	5C	Q297	2C	R275	4C	R412	2B
C259	5C	Q300	3C	R276	4D	R413	2C
C260	5C	Q303	2D	R278	4D	R414	2B
C266	5C	Q306	3D	R279	4D	R417	2B
C262	5C	Q310	2D	R281	3D	R418	2C
C276	4D	Q312	2D	R282	3D	R419	2C
C279	4D	Q316	3E	R284	3D	R422	3C
C281	3C	Q319	3D	R286	2C	R423	3C
C322	3E	Q324	4E	R287	2D	R424	3B
C372	5B	Q371	5B	R289	2D	R430	3B
C374	5D	Q375	5B	R292	2C	R432	3A
C385	5C	Q383	4C	R293	2C	R434	3A
C390	4B	Q388	3C	R295	2C	R436	4A
C391	3B	Q401	2B	R298	3D	R438	4B
C393	4B	Q404	3B	R299	3C	R440	4B
C395	3C	Q406	2B	R301	3C	R443	6B
C438	4A	Q409	2B	R304	3D	R1045	6B
C1043	6B	Q411	2B	R305	3D		
C1045	8C	Q414	2B	R307	3D	S444	6A
C1050	3C	Q416	2C	R310	2D		
C1053	6B	Q419	2C	R311	2E	TP240	8C
C1058	4A	Q421	2C	R313	2D	TP324	4D
C1061	4E	Q424	3C	R315	3E	TP440	4B
		Q431	3A	R316	4E		
CR222	8C	Q433	3B	R318	3E	U205	7C
CR223	8C	Q440	4A	R320	2E	U230	8D
CR248	7D			R322	4D	U240	8D
CR271	4D	R206	8C	R324	4D	U327	5D
CR370	6B	R207	8C	R326	6D	U329	6D
CR386	4B	R220	8E	R371	5B	U444	5A
CR398	3C	R222	8C	R372	5B		
		R225	8C	R373	5B	VR254	6B
L244	7D	R227	8D	R375	5B	VR263	5C
L253	6C	R234	8E	R376	5C	VR281	3C
L271	4C	R235	8D	R377	4B	VR287	2D
L378	4C	R237	8E	R378	4B	VR293	2C
		R239	8D	R381	5B	VR299	3D
LR265	4D	R242	8D	R384	4C	VR305	3D
LR380	5C	R244	7D	R385	5C	VR311	2D
LR383	4B	R245	7D	R387	4C	VR380	5C
		R246	7D	R389	4C	VR395	3C
P213	9D	R247	7D	R390	4B	VR403	3B
		R249	7D	R392	4B	VR408	2A
Q225	8D	R251	6D	R393	4B	VR413	2B
Q227	8D	R254	6B	R395	3B	VR418	2B
						VR423	3C



NOTE: ALL VOLTAGES ARE DECOUPLED, SEE \diamond FOR DETAILS.

SEE PARTS LIST FOR EARLIER VALUES AND SERIAL NUMBER RANGES OF PARTS MARKED WITH BLUE OUTLINE

REV. D, APR 1978

PHASE LOCK LOOP & GATED COUNTDOWN \diamond

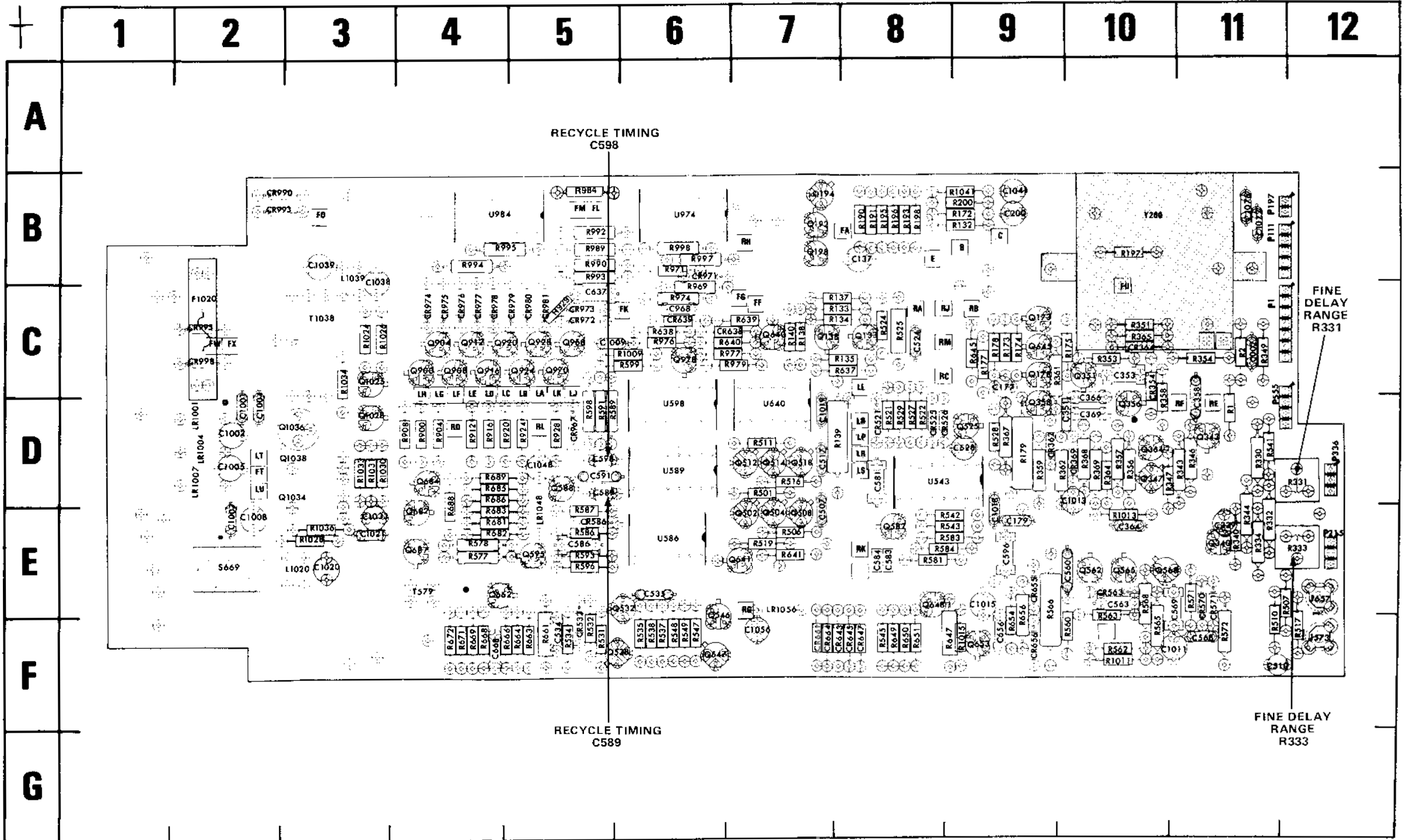
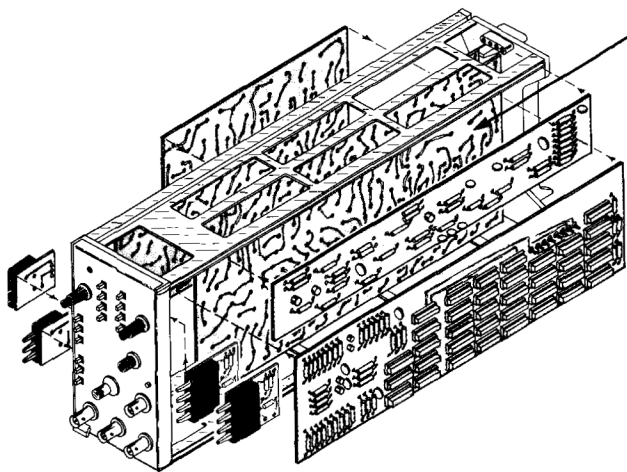

Fig. 6-7. A4—Interface circuit board.

CKT NO	GRID LOC	CKT NO	GRID LOC	CKT NO	GRID LOC	CKT NO	GRID LOC	CKT NO	GRID LOC	CKT NO	GRID LOC	CKT NO	GRID LOC
C108	9E	C1008	2E	CR971	6B	Q173	9C	Q904	4C	R501	7D	R682	4E
C137	8B	C1009	5C	CR972	5C	Q178	9C	Q908	4C	R506	7E	R683	4E
C177	9C	C1011	11F	CR973	5C	Q192	7B	Q912	4C	R507	12E	R685	4D
C179	9E	C1013	10D	CR974	4C	Q194	7B	Q916	4C	R510	11F	R686	4D
C200	9B	C1015	9E	CR975	4C	Q198	7B	Q920	4C	R511	7D	R688	4D
C339	11E	C1019	7D	CR976	4C	Q340	11E	Q924	5C	R516	7D	R689	4D
C351*†	10D	C1020	3E	CR977	4C	Q347	10D	Q928	5C	R517	12F	R900	4D
C353	10C	C1023	3E	CR978	4C	Q343	11D	Q968	5C	R519	7E	R904	4D
C358	11D	C1033	3E	CR979	5C	Q351	10C	Q970	5C	R521	8D	R908	4D
C364	10E	C1038	3C	CR980	5C	Q356	10D	Q978	6C	R522	8D	R912	4D
C366	10D	C1039	3B	CR981	5C	Q358	9D	Q1028	3D	R524	8C	R916	4D
C369	10D	C1041	9B	CR990	2B	Q364	10D	Q1025	3C	R525	8C	R920	4D
C507	7E	C1048	5D	CR993	3B	Q502	7E	Q1034	3D	R527	8D	R924	5D
C510	11F	C1056	7F	CR995	2C	Q504	7E	Q1036	3D	R528	9D	R928	5D
C517	7D	C1072	11B	CR998	2C	Q508	7E	Q1038	3D	R529	8D	R929*†	5C
C524	8C	C1076	11B			Q512	7D			R531	5F	R969	6C
C528	9D			F1020	2C	Q514	7D	R1	11D	R532	5F	R971	6B
C534	5F	CR225	8D			Q518	7D	R2	11C	R534	5F	R974	6C
C535	6E	CR354	10C	J573	12F	Q525	9D	R132	9B	R535	6F	R976	6C
C560	10E	CR362	9D	J657	12E	Q532	6E	R133	7C	R537	6F	R977	7C
C563	10E	CR364	10C			Q538	6F	R134	7C	R538	6F	R979	7C
C568	11F	CR369	10D	L1020	3E	Q546	6F	R135	8C	R541	11D	R984*†£	5B
C569	11E	CR521	8D	L1039	3B	Q547	6F	R137	7C	R542	8E	R989	5B
C581	8D	CR526	8D			Q562	10E	R138	7C	R543	8E	R990	5B
C583	8E	CR532	5F	LR1001	2D	Q565	10E	R139	7D	R545	8F	R992	5B
C584	8E	CR563	10E	LR1004	2D	Q568	10E	R140	7C	R547	6F	R993	5B
C586	5E	CR570	11E	LR1007	2D	Q582	8E	R172	9B	R548	6F	R994	4B
C589	5D	CR571	11E	LR1048	5E	Q588	5D	R173	9C	R549	6F	R995	4B
C591	5D	CR586	5E	LR1056	7E	Q595	5E	R174	9C	R560	10F	R997	6B
C596	9E	CR638	7C			Q640	7C	R175	10C	R562	10F	R998	6B
C598	5D	CR639	6C	P1	11C	Q641	7E	R177	9C	R565	10F	R1009	6C
C637	5C	CR643	7F	P111	11B	Q645	9C	R178	9C	R566	9E	R1011	10F
C656	9F	CR645	8F	P197	11B	Q648	8E	R179	9D	R568	10E	R1013	10E
C668	4F	CR647	8F	P215	12E	Q653	9F	R190	8B	R571	11E	R1015	9F
C968	6C	CR655	9E	P336	12D	Q662	4E	R191	8B	R572	11F	R1024	3C
C1001	2D	CR656	9F	P555	11D	Q682	4E	R193	8B	R577	4E	R1026	3C
C1002	2D	CR661	7F			Q684	4D	R195	8B	R578	4E	R1028	3E
C1004	2D	CR664	7F	Q133	8C	Q687	4E	R196	8B	R581	8E	R1030	3D
C1005	2D	CR967	5D	Q138	7C	Q900	4C	R197	10B	R583	8E	R1031	3D
C1007	2E							R198	8B	R584	8E	R1033	3D
								R200	9B	R586	5E	R1034	3C
								R330	11D	R587	5E	R1036	3E
								R331	12D	R593	5E	R1041	9B
								R332	11E	R596	5E		
								R333	12E	R599	6C	S669	2E
								R334	11E	R637	8C		
								R340	11E	R638	6C	T579	4E
								R343	11D	R639	7C	T1038	3C
								R344	11E	R640	7C		
								R346	11D	R641	7E	U543	8D
								R347	10D	R645	9C	U586	6E
								R349	11C	R647	9F	U589	6D
								R351	10C	R649	8F	U598	6D
								R353	10C	R650	8F	U640	7D
								R354	11C	R651	8F	U984	4B
								R356	10D	R654	9F	U974	6B
								R357	10D	R656	9F		
								R358	10D	R661	5F	Y200	10B
								R359	9D	R663	5F		
								R361	9C	R664	5F		
								R362	10D	R666	5F		
								R364	10D	R668	4F		
								R365	10C	R669	4F		
								R367	9D	R671	4F		
								R368	10D	R672	4F		
								R369	10D	R681	4E		



A4
INTERFACE
CIRCUIT BOARD

*See Parts List for
serial number ranges.

† BACK OF BOARD

£ RELOCATED TO FRONT OF
BOARD SN B100000 & UP.

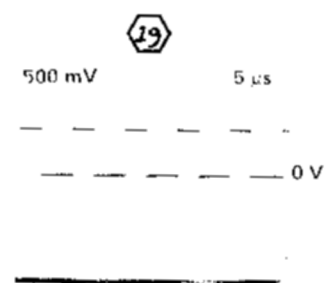
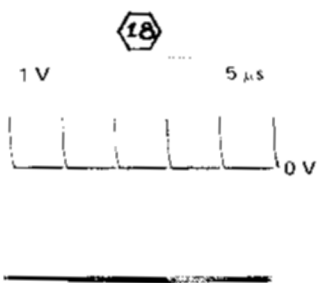
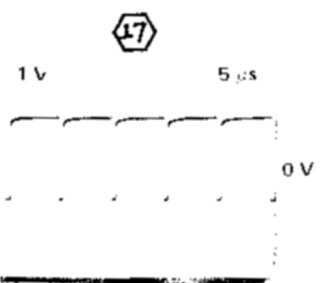
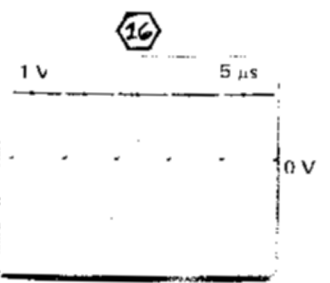
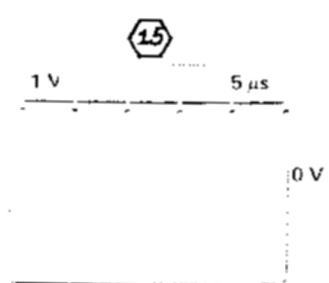
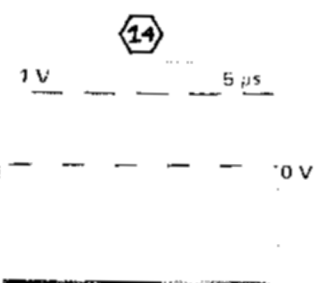
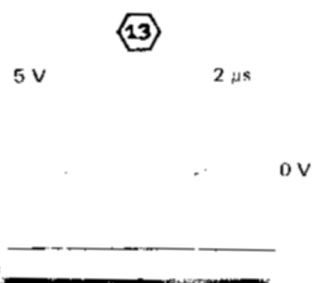
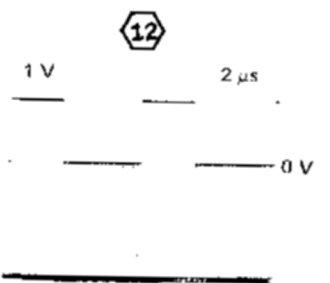
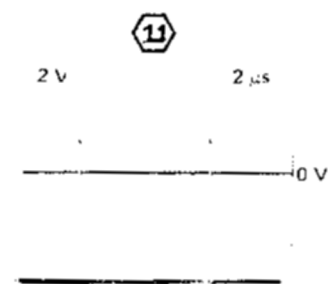
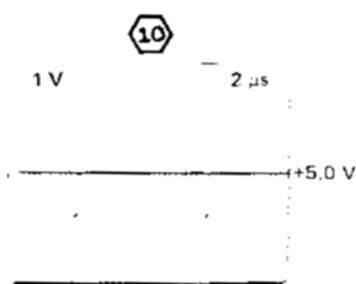
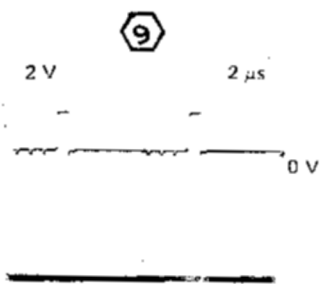
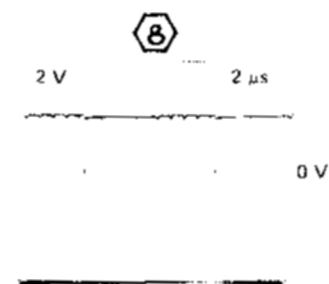
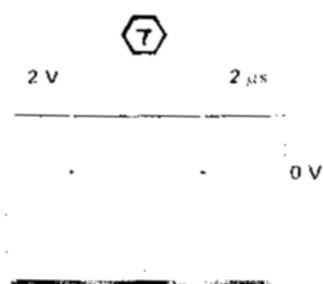
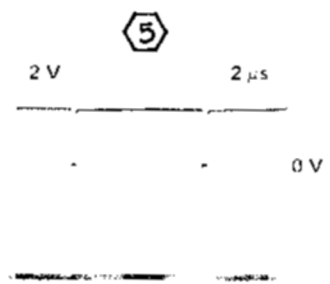
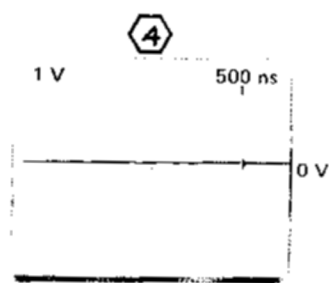
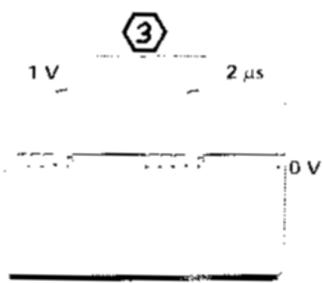
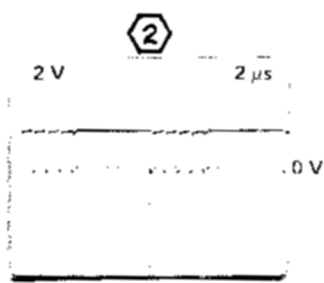
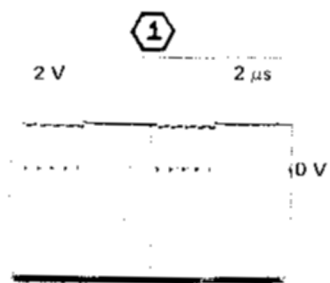

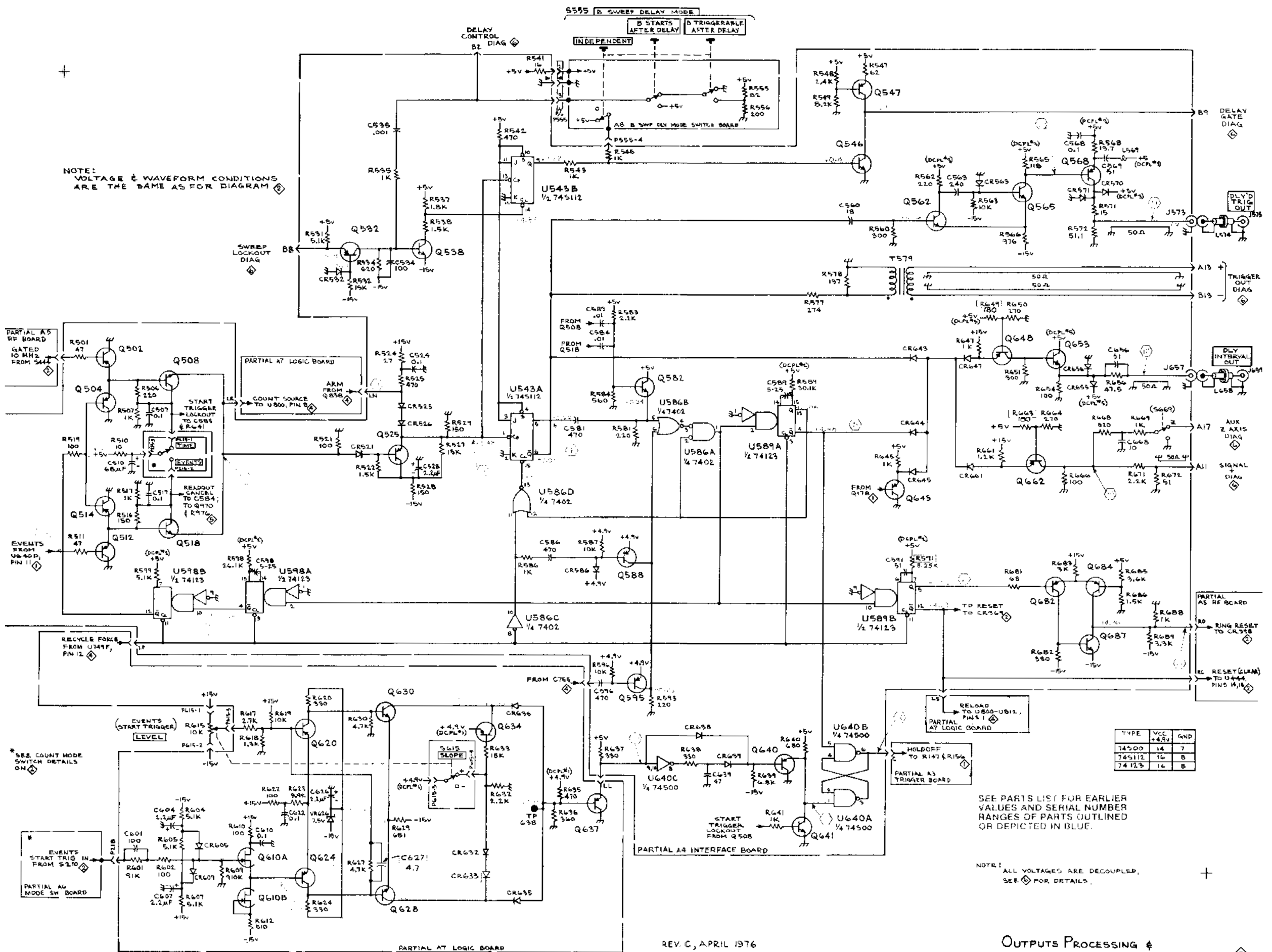

NOTE: VOLTAGE & WAVEFORM CONDITIONS ARE THE SAME AS FOR DIAGRAM

* SEE COUNT MODE SWITCH DETAILS

TYPE	VCC	GND
74500	14	7
745112	16	B
74123	16	B

SEE PARTS LIST FOR EARLIER VALUES AND SERIAL NUMBER RANGES OF PARTS OUTLINED OR DEPICTED IN BLUE.

NOTE: ALL VOLTAGES ARE DECOUPLED, SEE FOR DETAILS.

REV. C, APRIL 1976

OUTPUTS PROCESSING & EVENTS START TRIGGER

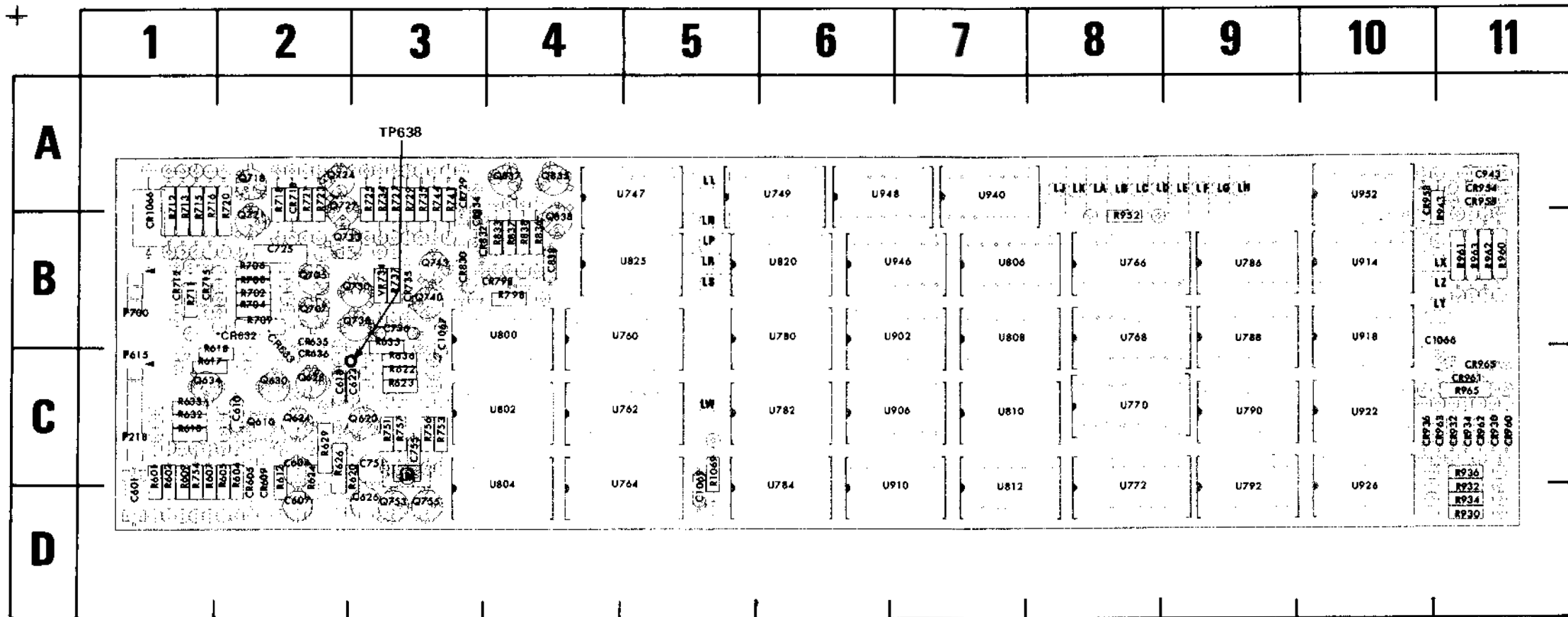

*See Parts List for serial number ranges.

Fig. 6-8. A7-Logic circuit board.

EV. B APR 1976

CKT NO	GRID LOC	CKT NO	GRID LOC	CKT NO	GRID LOC	CKT NO	GRID LOC	CKT NO	GRID LOC	CKT NO	GRID LOC
C601	1C	CR832	3B	Q724	2A	R632	1C	R756	3C	U772	8C
C604	2C	CR834	3A	Q727	2A	R633	1C	R757	3C	U780	6B
C607	2D	CR930	11C	Q730	3B	R635	3B	R798	4B	U782	6C
C610	2C	CR932	11C	Q733	2B	R636	3C	R833	4B	U784	6C
C618	2C	CR934	11C	Q738	3B	R702	2B	R836	4B	U786	9B
C622	3C	CR936	10C	Q740	3B	R704	2B	R837	4B	U788	9B
C626	3D	CR953	10A	Q743	3B	R706	2B	R838	4B	U790	9C
C725	2B	CR954	11A	Q753	3D	R708	2B	R930	11D	U792	9C
C736	3B	CR955	11A	Q755	3D	R709	2B	R932	11D	U800	4B
C751	3C	CR960	11C	Q835	4A	R711	1B	R934	11D	U802	4C
C755	3C	CR961	11C	Q837	4A	R712	1A	R936	11C	U804	4C
C838	4B	CR962	11C	Q838	4B	R713	1A	R952	8B	U806	7B
C943	11A	CR963	11C			R715	1A	R960	11B	U808	7B
C1066	11B	CR965	11C	R601	1C	R716	1A	R961	11B	U810	7C
C1067	3B	CR1066	1A	R602	1C	R718	2A	R962	11B	U812	7C
C1069	5C			R604	2C	R720	2A	R963	11B	U820	6B
		P218	1C	R605	2C	R721	2A	R965	11C	U825	5B
CR605	2C	P615	1C	R607	1C	R723	2A	R1069	5C	U902	6B
CR609	2C	P700	1B	R609	1C	R725	3A			U906	6C
CR632	2C			R610	1C	R727	3A	TP638	3C	U910	6C
CR633	2C	Q610	2C	R612	2C	R729	3A			U914	10B
CR635	2B	Q620	3C	R617	1C	R734	3A	U747	5A	U918	10B
CR636	2C	Q624	2C	R618	1B	R735	3A	U749	6A	U922	10C
CR712	1B	Q628	2C	R620	3C	R737	3B	U760	5B	U926	10D
CR715	2B	Q630	2C	R622	3C	R741	3A	U762	5C	U940	7A
CR718	2A	Q634	1C	R623	3C	R744	3A	U764	5C	U946	6B
CR729	3A	Q705	2B	R624	2C	R751	3C	U766	8B	U948	6A
CR735	3B	Q707	2B	R626	2C	R753	3C	U768	8B	U952	10A
CR798	4B	Q718	2A	R629	2C	R754	1C	U770	8C	VR734	3B
CR830	3B	Q721	2B								

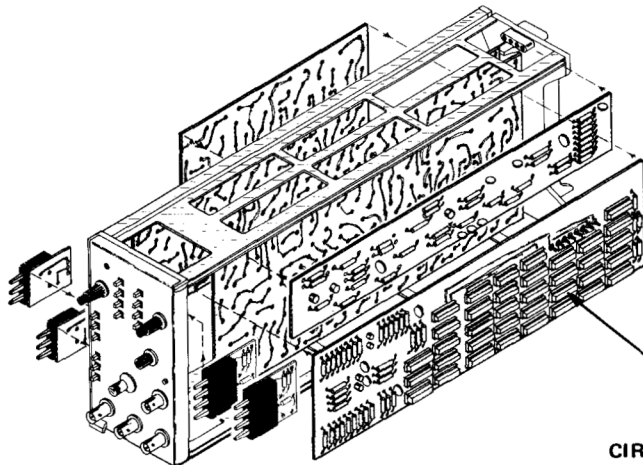

A7
LOGIC
CIRCUIT BOARD

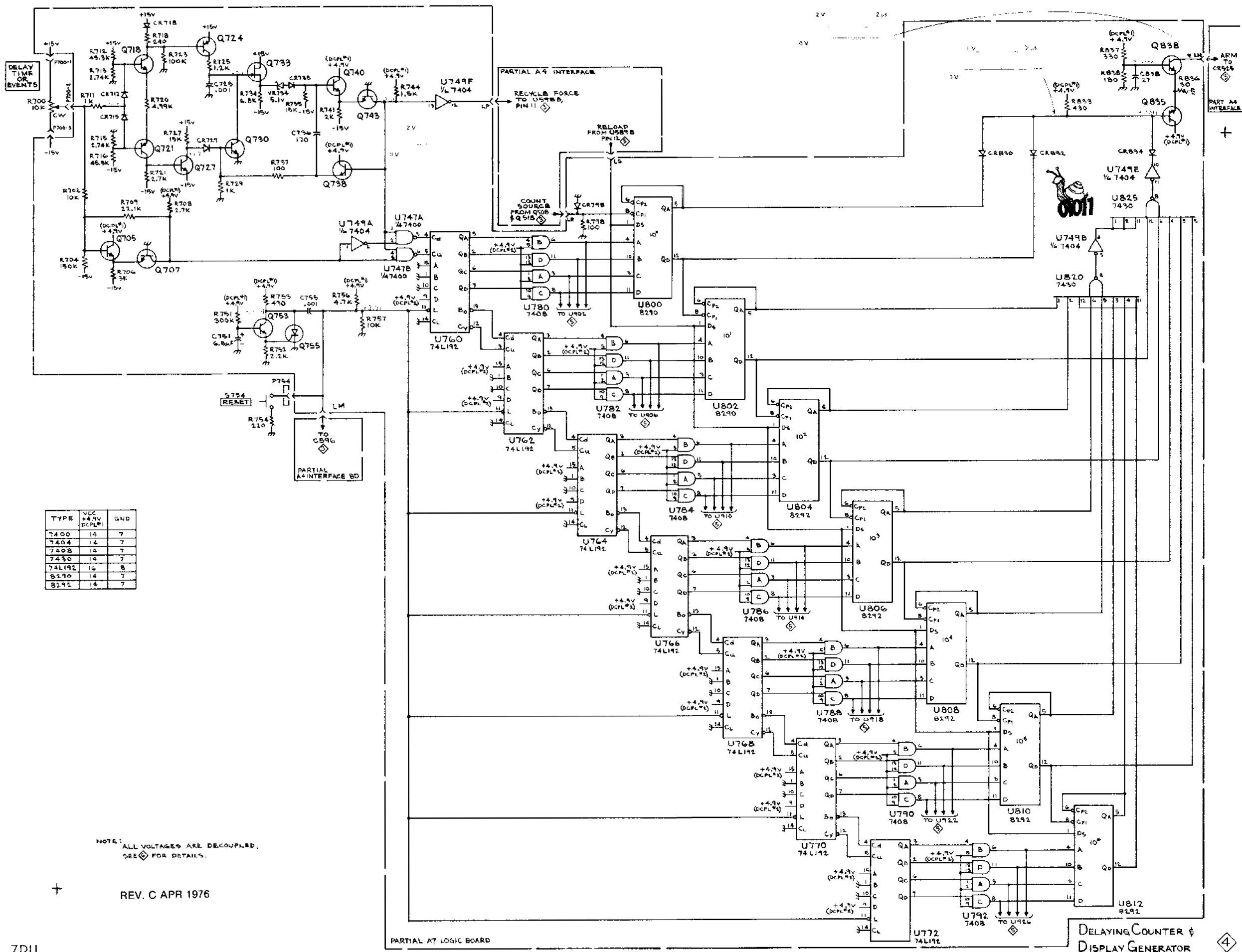

TYPE	VCC	GND
7400	+4.7V (DCPL*)	7
7404	+4.7V (DCPL*)	7
7408	+4.7V (DCPL*)	7
7430	+4.7V (DCPL*)	7
74L192	+4.7V (DCPL*)	8
8290	+4.7V (DCPL*)	7
8292	+4.7V (DCPL*)	7

NOTE: ALL VOLTAGES ARE DECOUPLED, SEE Ⓢ FOR DETAILS.

REV. C APR 1976

PARTIAL A7 LOGIC BOARD

DELAYING COUNTER &
DISPLAY GENERATOR

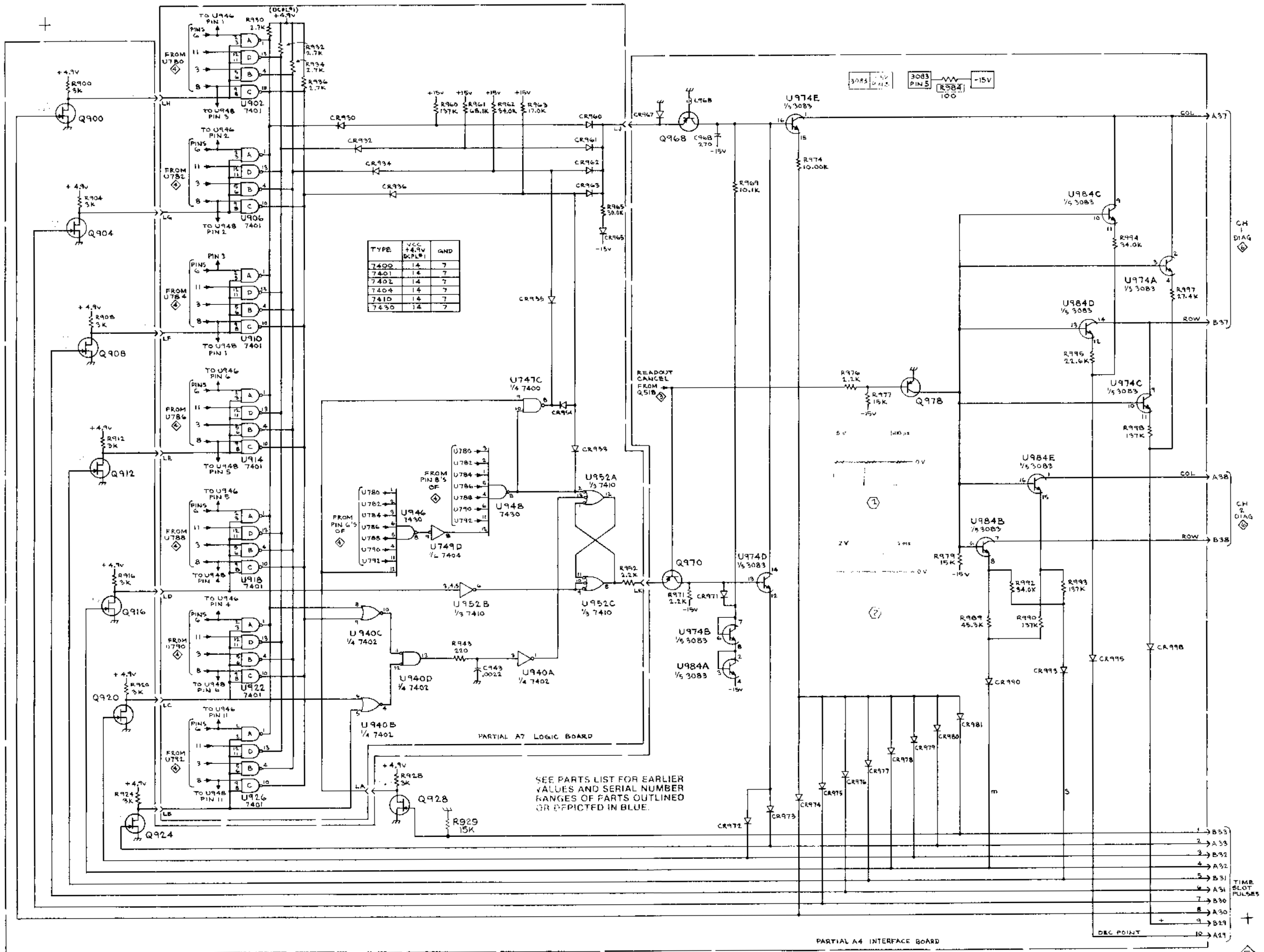

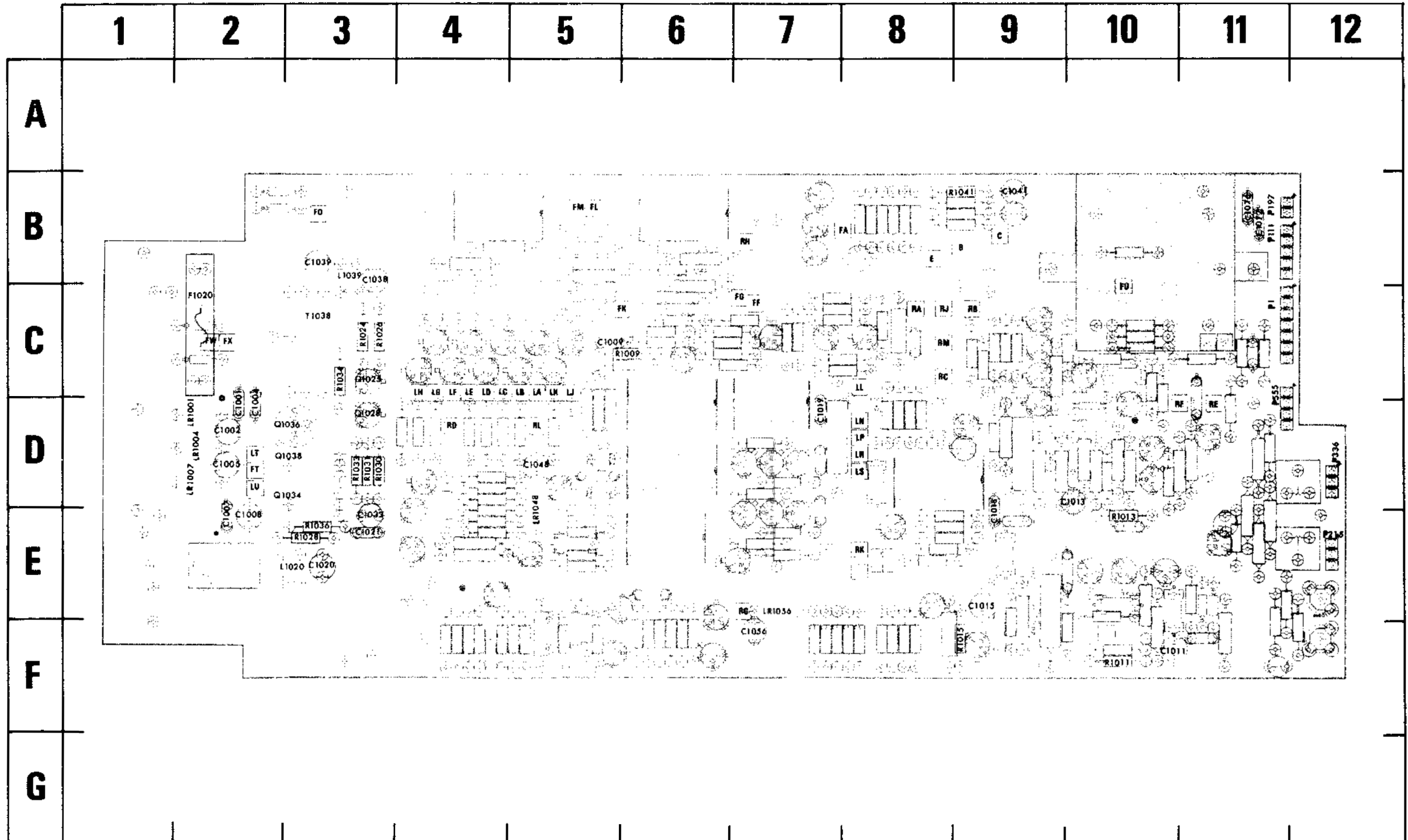
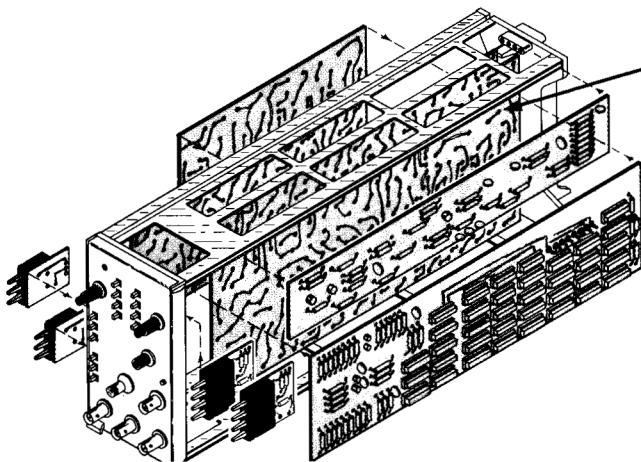
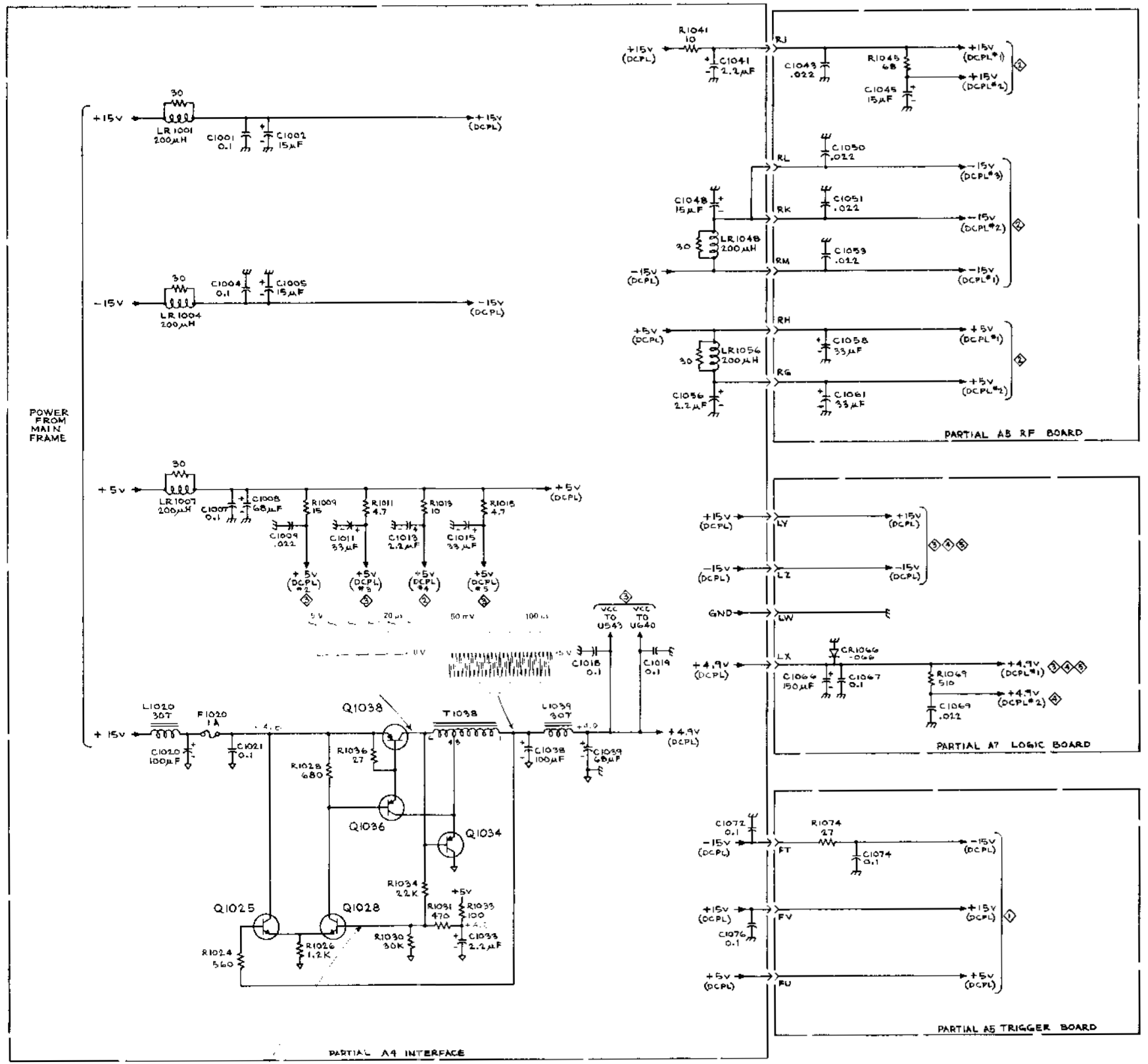
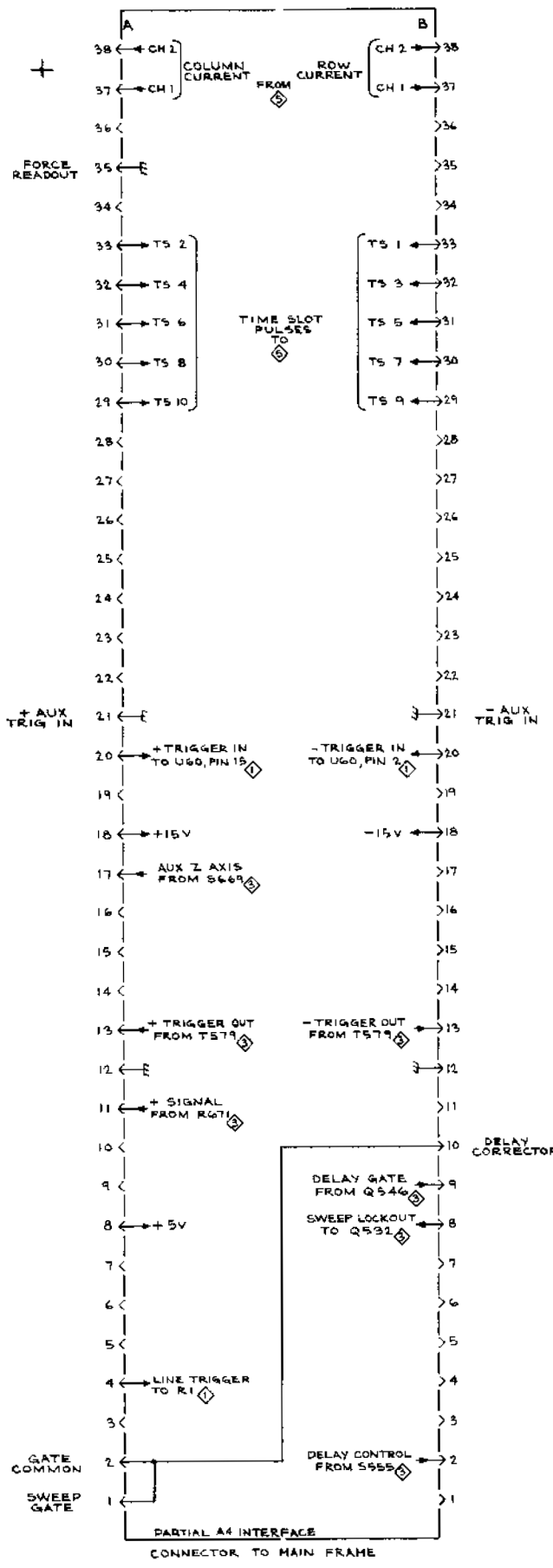

Fig. 6-9. A4-Voltage regulator and power distribution.



**A4
INTERFACE
CIRCUIT BOARD**

CKT NO	GRID LOC	CKT NO	GRID LOC	CKT NO	GRID LOC	CKT NO	GRID LOC
C1001	2D	C1039	3B	LR1048	5E	R1009	6C
C1002	2D	C1041	9B	LR1056	7E	R1011	10F
C1004	2D	C1048	5D			R1013	10E
C1005	2D	C1056	7F	P1	11C	R1015	9F
C1007	2E	C1072	11B	P111	11B	R1024	3C
C1008	2E	C1076	11B	P197	11B	R1026	3C
C1009	5C			P215	12E	R1028	3E
C1011	11F	F1020	2C	P336	12D	R1030	3D
C1013	10D			P555	11D	R1031	3D
C1015	9E	L1020	3E			R1033	3D
C1019	7D	L1039	3B	Q1028	3D	R1034	3C
C1020	3E			Q1025	3C	R1036	3E
C1023	3E	LR1001	2D	Q1034	3D	R1041	9B
C1033	3E	LR1004	2D	Q1036	3D		
C1038	3C	LR1007	2D	Q1038	3D	T1038	3C



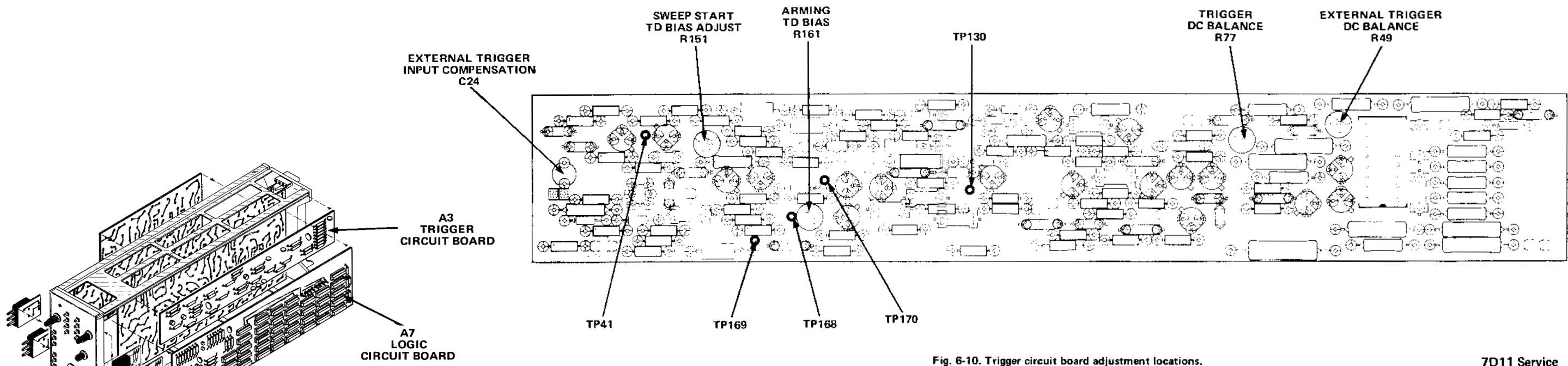

Fig. 6-10. Trigger circuit board adjustment locations.

7D11 Service

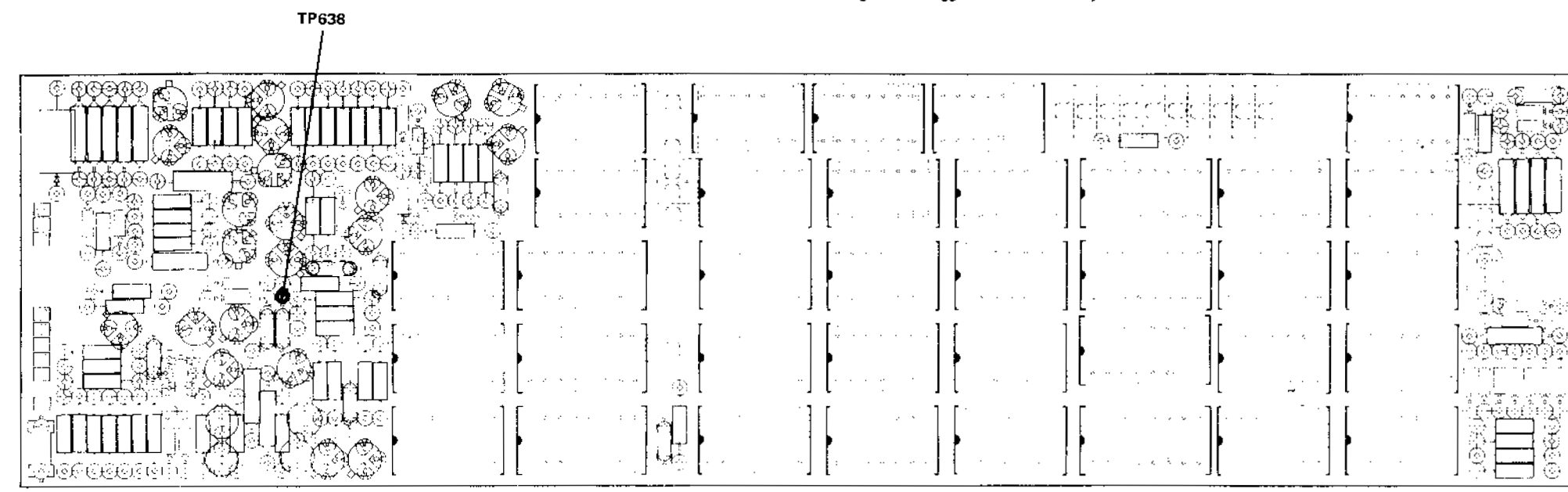
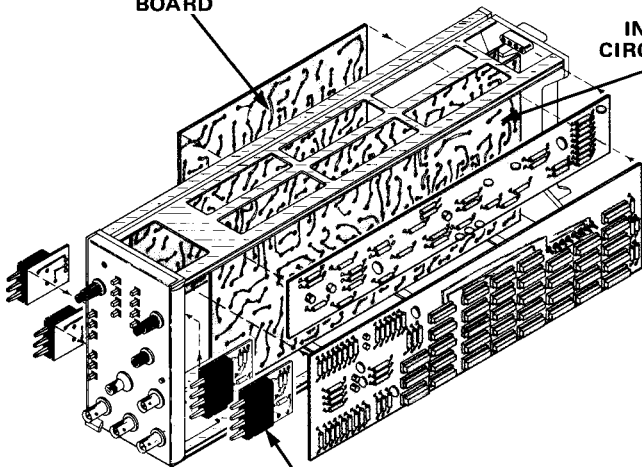

Fig. 6-11. Logic circuit board adjustment locations.

**A5
RF CIRCUIT
BOARD**

**A4
INTERFACE
CIRCUIT BOARD**



**A1
SOURCE SWITCH
CIRCUIT BOARD**

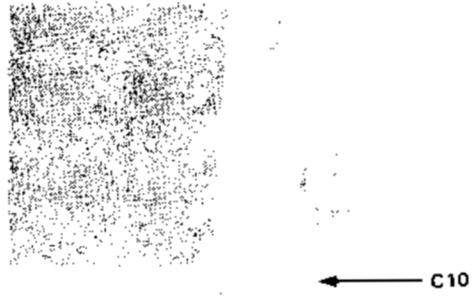

Fig. 6-12. Source switch adjustment locations.

TP440



500 MHz
CENTER TUNE
C258

TP240

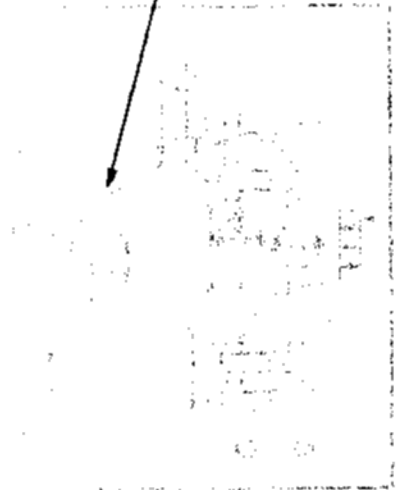

TP324

Fig. 6-13. RF circuit board adjustment locations.

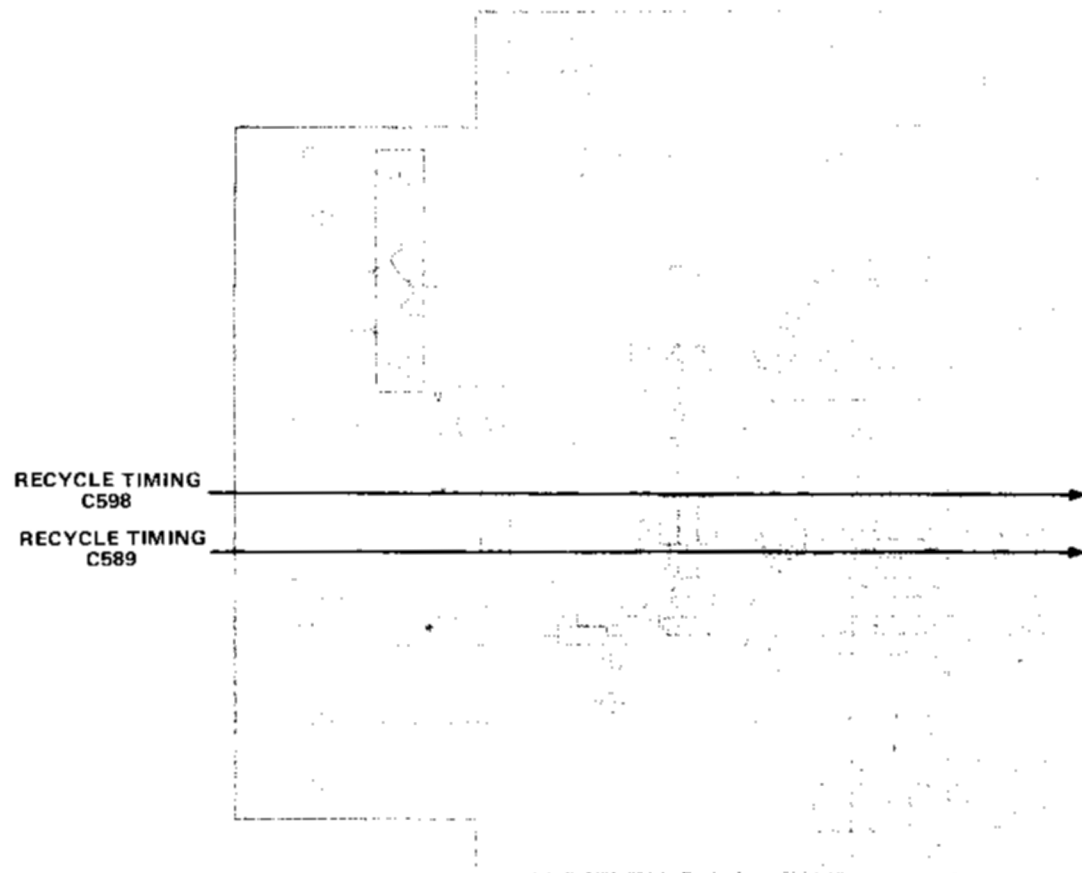
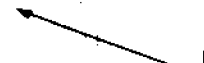

Fig. 6-14. Interface circuit board adjustment locations.

FINE
DELAY
RANGE
R331



FINE DELAY
RANGE
R333



REPLACEABLE MECHANICAL PARTS

PARTS ORDERING INFORMATION

Replacement parts are available from or through your local Tektronix, Inc. Field Office or representative.

Changes to Tektronix instruments are sometimes made to accommodate improved components as they become available, and to give you the benefit of the latest circuit improvements developed in our engineering department. It is therefore important, when ordering parts, to include the following information in your order: Part number, instrument type, or number, serial number, and modification number if applicable.

If a part you have ordered has been replaced with a new or improved part, your local Tektronix, Inc. Field Office or representative will contact you concerning any change in part number.

Change information, if any, is located at the rear of this manual.

SPECIAL NOTES AND SYMBOLS

- X000 Part first added at this serial number
- 00X Part removed after this serial number

FIGURE AND INDEX NUMBERS

Items in this section are referenced by figure and index numbers to the illustrations.

INDENTATION SYSTEM

This mechanical parts list is indented to indicate item relationships. Following is an example of the indentation system used in the description column.

```

1 2 3 4 5
Name & Description
Assembly and/or Component
Attaching parts for Assembly and/or Component
-----*-----
Detail Part of Assembly and/or Component
Attaching parts for Detail Part
-----*-----
Parts of Detail Part
Attaching parts for Parts of Detail Part
-----*-----
    
```

Attaching Parts always appear in the same indentation as the item it mounts, while the detail parts are indented to the right. Indented items are part of, and included with, the next higher indentation. The separation symbol ---*--- indicates the end of attaching parts.

Attaching parts must be purchased separately, unless otherwise specified.

ITEM NAME

In the Parts List, an Item Name is separated from the description by a colon (:). Because of space limitations, an Item Name may sometimes appear as incomplete. For further Item Name identification, the U.S. Federal Cataloging Handbook H6-1 can be utilized where possible.

ABBREVIATIONS

#	INCH	ELCTRN	ELECTRON	IN	INCH	SE	SINGLE END
ACTR	NUMBER SIZE	ELEC	ELECTRICAL	INCAND	INCANDESCENT	SECT	SECTION
ADPTR	ACTUATOR	ELCTLT	ELECTROLYTIC	INSUL	INSULATOR	SEMICOND	SEMICONDUCTOR
ALIGN	ADAPTER	ELEM	ELEMENT	INTL	INTERNAL	SHLD	SHIELD
AL	ALIGNMENT	EPL	ELECTRICAL PARTS LIST	LPHLDR	LAMPHOLDER	SHLDR	SHOULDERED
ASSEM	ALUMINUM	EQPT	EQUIPMENT	MACH	MACHINE	SKT	SOCKET
ASSY	ASSEMBLED	EXT	EXTERNAL	MECH	MECHANICAL	SL	SLIDE
ATTEN	ASSEMBLY	FIL	FILLISTER HEAD	MTG	MOUNTING	SLFLKG	SELF-LOCKING
AWG	ATTENUATOR	FLEX	FLEXIBLE	NIP	NIPPLE	SLVG	SLEEVING
BD	AMERICAN WIRE GAGE	FLH	FLAT HEAD	NON WIRE	NOT WIRE WOUND	SPR	SPRING
BRKT	BOARD	FLTR	FILTER	OB	ORDER BY DESCRIPTION	SQ	SQUARE
BRS	BRACKET	FR	FRAME or FRONT	OD	OUTSIDE DIAMETER	SST	STAINLESS STEEL
BRZ	BRASS	FSTNR	FASTENER	OVH	OVAL HEAD	STL	STEEL
BSHG	BRONZE	FT	FOOT	PH BRZ	PHOSPHOR BRONZE	SW	SWITCH
CAB	BUSHING	FXD	FIXED	PL	PLAIN or PLATE	T	TUBE
CAP	CABINET	GSKT	GASKET	PLSTC	PLASTIC	TERM	TERMINAL
CER	CAPACITOR	HDL	HANDLE	PN	PART NUMBER	THD	THREAD
CHAS	CERAMIC	HEX	HEXAGON	PNH	PAN HEAD	THK	THICK
CKT	CHASSIS	HEX HD	HEXAGONAL HEAD	PWR	POWER	TNSN	TENSION
COMP	CIRCUIT	HEX SOC	HEXAGONAL SOCKET	RCPT	RECEPTACLE	TPG	TAPPING
CONN	COMPOSITION	HLCPS	HELICAL COMPRESSION	RES	RESISTOR	TRH	TRUSS HEAD
COV	CONNECTOR	HLEXT	HELICAL EXTENSION	RGD	RIGID	V	VOLTAGE
CPLG	COVER	HV	HIGH VOLTAGE	RLF	RELIEF	VAR	VARIABLE
CRT	COUPLING	IC	INTEGRATED CIRCUIT	RTNR	RETAINER	W/	WITH
DEG	CATHODE RAY TUBE	ID	INSIDE DIAMETER	SCH	SOCKET HEAD	WSHR	WASHER
DWR	DEGREE	IDENT	IDENTIFICATION	SCOPE	OSCILLOSCOPE	XFMR	TRANSFORMER
	DRAWER	IMPLR	IMPELLER	SCR	SCREW	XSTR	TRANSISTOR

CROSS INDEX—MFR. CODE NUMBER TO MANUFACTURER

Mfr. Code	Manufacturer	Address	City, State, Zip
00779	AMP, INC.	P O BOX 3608	HARRISBURG, PA 17105
01295	TEXAS INSTRUMENTS, INC., SEMICONDUCTOR GROUP	P O BOX 5012, 13500 N CENTRAL EXPRESSWAY	DALLAS, TX 75222
05091	TRI-ORDINATE CORPORATION	343 SNYDER AVENUE	BERKELEY HEIGHTS, NJ 07922
08261	SPECTRA-STRIP CORP.	7100 LAMPSON AVE.	GARDEN GROVE, CA 92642
12327	FREEWAY CORPORATION	9301 ALLEN DRIVE	CLEVELAND, OH 44125
13257	AMERACE, LTD.	10 ESNA PARK DRIVE	MARKHAM, ONTARIO, CANADA
22526	BERG ELECTRONICS, INC.	YOUK EXPRESSWAY	NEW CUMBERLAND, PA 17070
73743	FISCHER SPECIAL MFG. CO.	446 MORGAN ST.	CINCINNATI, OH 45206
74445	HOLO-KROME CO.	31 BROOK ST. WEST	HARTFORD, CT 06110
76854	OAK INDUSTRIES, INC., SWITCH DIV.	S. MAIN ST.	CRYSTAL LAKE, IL 60014
77250	PHEOLL MANUFACTURING CO., DIVISION OF ALLIED PRODUCTS CORP.	5700 W. ROOSEVELT RD.	CHICAGO, IL 60650
78189	ILLINOIS TOOL WORKS, INC. SHAKEPROOF DIVISION	ST. CHARLES ROAD	ELGIN, IL 60120
79136	WALDES, KOHINOOR, INC.	47-16 AUSTEL PLACE	LONG ISLAND CITY, NY 11101
79727	C-W INDUSTRIES	550 DAVISVILLE RD., P O BOX 96	WARMINISTER, PA 18974
80009	TEKTRONIX, INC.	P O BOX 500	BEAVERTON, OR 97077
81073	GRAYHILL, INC.	561 HILLGROVE AVE., PO BOX 373	LA GRANGE, IL 60525
83385	CENTRAL SCREW CO.	2530 CRESCENT DR.	BROADVIEW, IL 60153
87308	N. L. INDUSTRIES, INC., SOUTHERN SCREW DIV.	P. O. BOX 1360	STATESVILLE, NC 28677

Fig. & Index No.	Tektronix Part No.	Serial/Model No.		Qty	1 2 3 4 5	Name & Description	Mfr Code	Mfr Part Number
		Eff	Dscont					
1-1	366-1391-00			2		KNOB:GRAY	80009	366-1391-00
-2	366-1077-00			2		KNOB:GRAY	80009	366-1077-00
	-----			-		. EACH KNOB INCLUDES:		
	213-0153-00			1		. SETSCREW:5-40 X 0.125 INCH,HEX SOC STL	74445	OBD
-3	366-1410-00			1		KNOB:GRAY,MARKED 0-100	80009	366-1410-00
-4	366-0494-00	B010100	B089999	1		KNOB:GRAY	80009	366-0494-00
	366-0494-04	B090000		1		KNOB:GRAY	80009	366-0494-04
	213-0153-00			1		. SETSCREW:5-40 X 0.125 INCH,HEX SOC STL	74445	OBD
-5	366-1058-47			1		KNOB:LATCH	80009	366-1058-47
						(ATTACHING PARTS)		
-6	214-1095-00			1		PIN,SPG,SPLIT:0.094 OD X 0.187 INCH LONG	13257	52-022-094-0187
						- - - * - - -		
-7	105-0076-00	B010100	B081324	1		REL BAR,LATCH:PLUG-IN UNIT	80009	105-0076-00
	105-0076-02	B081325		1		REL BAR,LATCH:PLUG-IN UNIT	80009	105-0076-02
-8	214-1280-00			1		SPRING,HLCPS:0.14 OD X 1.126"L,0.16"DIA W	80009	214-1280-00
-9	105-0075-00			1		PAWL:0.475 X 0.21 X 0.184 INCH,PLSTC	80009	105-0075-00
-10	214-1054-00			1		SPRING,DETENT:LATCH	80009	214-1054-00
-11	348-0235-00			2		SHLD GSKT,ELEC:4.734 INCH LONG	80009	348-0235-00
	333-1595-00	B010100	B029999	1		PANEL,FRONT:7D11	80009	333-1595-00
-12	333-1595-01	B030000		1		PANEL,FRONT:7D11	80009	333-1595-01
-13	352-0157-00			1		LAMPHOLDER:WHITE PLASTIC	80009	352-0157-00
-14	378-0602-00			1		LENS,LIGHT:GREEN	80009	378-0602-00
-15	200-0935-00			1		BASE,LAMPHOLDER:0.29 OD X 0.19 CASE	80009	200-0935-00
-16	131-0955-00			1		CONNECTOR,RCPT,:BNC,FEMALE,W/HARDWARE	05091	31-279
-17	131-0955-00			3		CONNECTOR,RCPT,:BNC,FEMALE,W/HARDWARE	05091	31-279
						(ATTACHING PARTS FOR EACH)		
-18	210-0255-00			1		TERMINAL,LUG:0.391" ID INT TOOTH	80009	210-0255-00
						- - - * - - -		
-19	-----			3		RESISTOR,VARIABLE:		
						(ATTACHING PARTS FOR EACH)		
-20	210-0583-00			1		NUT,PLAIN,HEX.:0.25-32 X 0.312 INCH,BRS	73743	2X20224-402
						- - - * - - -		
-21	-----			1		RESISTOR,VARIABLE:		
						(ATTACHING PARTS)		
-22	210-0583-00			1		NUT,PLAIN,HEX.:0.25-32 X 0.312 INCH,BRS	73743	2X20224-402
-23	210-0465-00			1		NUT,PLAIN,HEX.:0.25-32 X 0.375 INCH BRS	73743	3095-402
						- - - * - - -		
-24	376-0014-00			1		CPLG,SHAFT,FLEX:SST WIRE	76854	22675-001
-25	386-2173-00			1		SPRT,KNOB ASSY:	80009	386-2173-00
						(ATTACHING PARTS)		
-26	211-0109-00			2		SCREW,MACHINE:4-40 X 0.875"100 DEG,FLH STL	83385	OBD
						- - - * - - -		
-27	200-1339-00			1		COVER,HOUSING:VARIABLE RESISTOR	80009	200-1339-00
-28	214-1702-00			1		SPR,HLCL,TRSN:0.215 INCH OD	80009	214-1702-00
-29	384-1130-00			1		EXTENSION SHAFT:	80009	384-1130-00
-30	380-0273-00			1		HOUSING,SHAFT:	80009	380-0273-00
-31	260-0735-00	XB030000		1		SWITCH,PUSH:SPST	81073	39-1
						(ATTACHING PARTS)		
-32	210-0008-00	XB030000		1		WASHER,LOCK:INTL,0.172 ID X 0.331"OD,STL	78189	1208-00-00-0541C
						- - - * - - -		
-33	352-0171-00	XB030000		1		CONN BODY,PL,EL:1 WIRE BLACK	80009	352-0171-00
-34	-----			1		CKT BOARD ASSY:--SOURCE SWITCH(SEE A1 EPL)		
						(ATTACHING PARTS)		
	211-0156-00			2		SCREW,MACHINE:1-72 X 0.25",82 DEG,FLH STL	77250	OBD
						- - - * - - -		
	-----			-		. CIRCUIT BOARD ASSEMBLY INCLUDES:		
-35	131-0608-00			2		. CONTACT,ELEC:0.365 INCH LONG	22526	47357
-36	-----			1		CKT BOARD ASSY:--COUPLING SWITCH(SEE A2 EPL)		
						(ATTACHING PARTS)		
	211-0156-00			2		SCREW,MACHINE:1-72 X 0.25",82 DEG,FLH STL	77250	OBD
						- - - * - - -		

Replaceable Mechanical Parts—7D11

Fig. & Index No.	Tektronix Part No.	Serial/Model No. Eff Dscent	Qty	1	2	3	4	5	Name & Description	Mfr Code	Mfr Part Number
1-37	-----		1						CKT BOARD ASSY:--B SWP DLY MODE SW(SEE A8 EPL) (ATTACHING PARTS)		
-38	211-0156-00		2						SCREW,MACHINE:1-72 X 0.25",82 DEG,FLH STL - - - * - - -	77250	OBD
-39	-----		1						CKT BOARD ASSY:--COUNT MODE SW(SEE A6 EPL) (ATTACHING PARTS)		
	211-0156-00		2						SCREW,MACHINE:1-72 X 0.25",82 DEG,FLH STL - - - * - - -	77250	OBD
-40	386-1447-66		1						SUBPANEL,FRONT: (ATTACHING PARTS)	80009	386-1447-66
-41	213-0192-0		4						SCR,TPG,THD FOR:6-32 X 0.50 INCH,PNH STL - - - * - - -	87308	OBD
-42	337-1064-04		2						SHIELD,ELEC:RIGHT SIDE	80009	337-1064-00
-43	-----		1						CKT BOARD ASSY:--LOGIC(SEE A7 EPL)		
	-----		-						. CIRCUIT BOARD ASSY INCLUDES:		
-44	131-0608-00	B010100 B029999	9						. CONTACT,ELEC:0.365 INCH LONG	22526	47357
	131-0608-00	B030000	10						. CONTACT,ELEC:0.365 INCH LONG	22526	47357
-45	136-0252-04	B010100 B029999	66						. SOCKET,PIN TERM:0.188 INCH LONG	22526	75060
	136-0252-04	B030000	69						. SOCKET,PIN TERM:0.188 INCH LONG	22526	75060
-46	136-0260-02		7						. SOCKET,PLUG-IN:16 CONTACT,LOW CLEARANCE	01295	C931602
-47	136-0263-03	B010100 B060959	20						. SOCKET,PIN TERM:FOR 0.025 INCH SQUARE PIN	00779	86250-2
	136-0263-04	B060960	20						. SOCKET,PIN TERM:FOR 0.025 INCH SQUARE PIN	22526	75377-001
-48	136-0269-02		29						. SOCKET,PLUG-IN:14 CONTACT,LOW CLEARANCE	01295	C931402
-49	211-0155-00		3						. SCREW,EXT,RLV B:4-40 X 0.375 INCH,SST	80009	211-0155-00
-50	214-0579-00		1						. TERM.,TEST PT:0.40 INCH LONG	80009	214-0579-00
-51	361-0238-00		3						. SPACER,SLEEVE:0.25 OD X 0.34 INCH LONG	80009	361-0238-00
-52	-----		1						CKT BOARD ASSY:--TRIGGER(SEE A3 EPL)		
	-----		-						. CIRCUIT BOARD ASSY INCLUDES:		
-53	131-0608-00		2						. CONTACT,ELEC:0.365 INCH LONG	22526	47357
-54	136-0252-04		60						. SOCKET,PIN TERM:0.188 INCH LONG	22526	75060
-55	136-0260-02		1						. SOCKET,PLUG-IN:16 CONTACT,LOW CLEARANCE	01295	C931602
-56	136-0263-03	B010100 B060959	15						. SOCKET,PIN TERM:FOR 0.025 INCH SQUARE PIN	00779	86250-2
	136-0263-04	B060960	15						. SOCKET,PIN TERM:FOR 0.025 INCH SQUARE PIN	22526	75377-001
-57	200-0945-00		1						. COVER,HALF XSTR:FOR DUAL TO-18 CASE	80009	200-0945-00
-58	200-0945-01		1						. COVER,HALF XSTR:FOR DUAL TO-18 CS,2-56 THD	80009	200-0945-01
-59	211-0062-00		1						. SCREW,MACHINE:2-56 X 0.312 INCH,RDH STL	83385	OBD
-60	211-0155-00		3						. SCREW,EXT,RLV B:4-40 X 0.375 INCH,SST	80009	211-0155-00
-61	214-0579-00		5						. TERM.,TEST PT:0.40 INCH LONG	80009	214-0579-00
-62	352-0213-00		7						. HOLDER,CABLE:FOR 0.16 X 0.08"CABLE,PLASTIC	80009	352-0213-00
-63	352-0228-00		3						. HOLDER,CABLE:FOR 0.125"DIA CABLE,PLASTIC	80009	352-0228-00
-64	352-0238-00		4						. HOLDER,COAXIAL:GROUNDING,FOR 0.125" DIA	80009	352-0238-00
-65	361-0238-00		3						. SPACER,SLEEVE:0.25 OD X 0.34 INCH LONG	80009	361-0238-00
-66	-----		1						CKT BOARD ASSY:--RF(SEE A5 EPL)		
	-----		-						. CIRCUIT BOARD ASSY INCLUDES:		
-67	131-0608-00		4						. CONTACT,ELEC:0.365 INCH LONG	22526	47357
-68	136-0252-04		122						. SOCKET,PIN TERM:0.188 INCH LONG	22526	75060
-69	136-0260-02		1						. SOCKET,PLUG-IN:16 CONTACT,LOW CLEARANCE	01295	C931602
-70	136-0263-03	B010100 B060959	12						. SOCKET,PIN TERM:FOR 0.025 INCH SQUARE PIN	00779	86250-2
	136-0263-04	B060960	12						. SOCKET,PIN TERM:FOR 0.025 INCH SQUARE PIN	22526	75377-001
-71	136-0269-02		4						. SOCKET,PLUG-IN:14 CONTACT,LOW CLEARANCE	01295	C931402
	200-0945-00		2						. COVER,HALF XSTR:FOR DUAL TO-18 CASE	80009	200-0945-00
-72	200-0945-01		2						. COVER,HALF XSTR:FOR DUAL TO-18 CS,2-56 THD	80009	200-0945-01
-73	211-0062-00		2						. SCREW,MACHINE:2-56 X 0.312 INCH,RDH STL	83385	OBD
-74	211-0155-00		4						. SCREW,EXT,RLV B:4-40 X 0.375 INCH,SST	80009	211-0155-00
-75	214-0579-00		3						. TERM.,TEST PT:0.40 INCH LONG	80009	214-0579-00
-76	260-0723-00		1						. SWITCH,SLIDE:DPDT,0.5A,125VAC	79727	GF126-0028
-77	351-0213-00		8						. GUIDE-POST,LOCK:0.285 INCH LONG	80009	351-0213-00
-78	361-0238-00		4						. SPACER,SLEEVE:0.25 OD X 0.34 INCH LONG	80009	361-0238-00
-79	337-1633-00		1						SHIELD,ELEC:POWER SUPPLY (ATTACHING PARTS)	80009	337-1633-00
-80	211-0008-00		8						SCREW,MACHINE:4-40 X 0.25 INCH,PNH STL	83385	OBD
-81	210-0870-00		8						WASHER,FLAT:0.14 ID X 0.312 INCH OD STL - - - * - - -	12327	OBD
	-----		-						. SHIELD INCLUDES:		
-82	252-0597-01		IN						. PLASTIC SHEET:7.0 X 8.0 INCH NICKEL PLATED	80009	252-0597-00

Fig. & Index No.	Tektronix Part No.	Serial/Model No. Eff Dscont	Qty	1	2	3	4	5	Name & Description	Mfr Code	Mfr Part Number
1-	-----		-						. SHIELD INCLUDES:		
-82	252-0597-01		IN						. PLASTIC SHEET:7.0 X 8.0 INCH NICKEL PLATED	80009	252-0597-00
-83	337-1657-00		1						SHIELD,ELEC:SWITCH	80009	337-1657-00
									(ATTACHING PARTS)		
-84	211-0022-00		2						SCREW,MACHINE:2-56 X 0.188 INCH,PNH STL	83385	OBD
									-----*		
	342-0368-00	XB090000	1						INSULATOR,FILM:SHIELD,1.6 L X 0.3W	80009	342-0368-00
-85	-----		1						CKT BOARD ASSY:--INTERFACE(SEE A4 EPL)		
									(ATTACHING PARTS)		
-86	211-0116-00		6						SCR,ASSEM WSHR:4-40 X 0.312 INCH,PNH BRS	83385	OBD
-87	211-0105-00		6						SCREW,MACHINE:4-40 X 0.188"100 DEG,FLH STL	83385	OBD
-88	220-0547-01		6						NUT,BLOCK:0.38 X 0.25 X 0.282"OA	80009	220-0547-01
									-----*		
-89	-----		-						. CIRCUIT BOARD ASSY INCLUDES:		
			1						. OSCILLATOR,RF:		
									(ATTACHING PARTS)		
-90	211-0007-00		4						. SCREW,MACHINE:4-40 X 0.188 INCH,PNH STL	83385	OBD
-91	129-0222-00		2						. SPACER,POST:0.27 L,W/4-40THD THRU,PLSTC	80009	129-0222-00
									-----*		
-92	131-0592-00		47						. CONTACT,ELEC:0.885 INCH LONG	22526	47353
-93	131-0608-00		24						. CONTACT,ELEC:0.365 INCH LONG	22526	47357
-94	131-1003-00		2						. CONNECTOR BODY,:CKT CD MT,3 PRONG	80009	131-1003-00
-95	136-0252-04	B010100 B029999	158						. SOCKET,PIN TERM:0.188 INCH LONG	22526	75060
	136-0252-04	B030000	164						. SOCKET,PIN TERM:0.188 INCH LONG	22526	75060
	136-0234-00		4						. SOCKET,PIN TERM:0.088 OD X 0.247 INCH L	00779	380598-1
-96	136-0260-02		5						. SOCKET,PLUG-IN:16 CONTACT,LOW CLEARANCE	01295	C931602
-97	136-0269-02		2						. SOCKET,PLUG-IN:14 CONTACT,LOW CLEARANCE	01295	C931402
-98	260-0723-00		1						. SWITCH,SLIDE:DPDT,0.5A,125VAC	79727	GF126-0028
-99	344-0154-00		2						. CLIP,ELECTRICAL:FOR 0.25 INCH DIA FUSE	80009	344-0154-00
-100	351-0186-00		10						. GUIDE-POST,LOCK:0.84 INCH LONG	80009	351-0186-00
-101	351-0213-00		2						. GUIDE-POST,LOCK:0.285 INCH LONG	80009	351-0213-00
-102	352-0274-00		3						. HOLDER,TERMINAL:FOR 8 SQUARE PINS	80009	352-0274-00
-103	386-1559-00		3						. SPACER,CKT CARD:PLASTIC	80009	386-1559-00
-104	361-0124-00		2						. POST,ELEC-MECH:HEX,2-56 X 0.156 X 0.937"L	80009	361-0124-00
									(ATTACHING PARTS FOR EACH)		
-105	211-0022-00		1						. SCREW,MACHINE:2-56 X 0.188 INCH,PNH STL	83385	OBD
									-----*		
-106	-----		2						. TRANSISTOR		
									(ATTACHING PARTS FOR EACH)		
-107	211-0012-00		1						. SCREW,MACHINE:4-40 X 0.375 INCH,PNH STL	83385	OBD
-108	210-1122-00		1						. WASHER,LOCK:0.228 ID X 0.375 INCH OD,STL	78189	4704-04-02
									-----*		
-109	386-1402-00		1						PANEL,REAR:	80009	386-1402-00
									(ATTACHING PARTS)		
-110	213-0192-00		4						SCR,TPG,THD FOR:6-32 X 0.50 INCH,PNH STL	87308	OBD
-111	361-0326-00		1						SPACER,SLEEVE:0.18 ID X 0.25 OD X 0.10"L	80009	361-0326-00
									-----*		
-112	214-1061-00		1						SPRING,GROUND:FLAT	80009	214-1061-00
-113	426-0505-11		1						FR SECT,PLUG-IN:TOP	80009	426-0505-11
-114	426-0499-11		1						FR SECT,PLUG IN:BOTTOM	80009	426-0499-11
-115	354-0350-00		1						RING,RETAINING:0.073"FREE ID X 0.015",STL	79136	5133-9MD
-116	358-0665-00		1						SPACER,SLEEVE:0.13 ID X 0.155 OD X 0.18"L	80009	358-0465-00
-117	131-0707-00		41						CONTACT,ELEC:0.48"L,22-26 AWG WIRE	22526	75691-005
-118	210-0774-00		2						EYELET,METALLIC:0.152 OD X 0.245 INCH L,BRS	80009	210-0774-00
-119	210-0775-00		2						EYELET,METALLIC:0.126 OD X 0.23 INCH L,BRS	80009	210-0775-00
-120	175-0825-00		FT						WIRE,ELECTRICAL:2 WIRE RIBBON	08261	OBD
-121	175-0826-00		FT						WIRE,ELECTRICAL:3 WIRE RIBBON	80009	175-0826-00
-122	175-0827-00		FT						WIRE,ELECTRICAL:4 WIRE RIBBON	08261	TEK-175-0827-00
-123	175-0828-00		FT						WIRE,ELECTRICAL:5 WIRE RIBBON	08261	OBD
-124	175-0830-00		FT						WIRE,ELECTRICAL:7 WIRE RIBBON	08261	OBD
-125	352-0171-00		1						CONN BODY,PL,EL:1 WIRE BLACK	80009	352-0171-00
-126	352-0169-01		1						CONN BODY,PL,EL:2 WIRE BROWN	80009	352-0169-01
	352-0169-03		1						CONN BODY,PL,EL:2 WIRE ORANGE	80009	352-0169-03
-127	352-0161-01		1						CONN BODY,PL,EL:3 WIRE BROWN	80009	352-0161-01
	352-0161-05		1						CONN BODY,PL,EL:3 WIRE GREEN	80009	352-0161-05
	352-0161-06		1						CONN BODY,PL,EL:3 WIRE BLUE	80009	352-0161-06
-128	352-0162-01		2						CONN BODY,PL,EL:4 WIRE BROWN	80009	352-0162-01
-129	352-0163-02		2						CONN BODY,PL,EL:5 WIRE RED	80009	352-0163-02
-130	352-0165-03		1						CONN BODY,PL,EL:7 WIRE ORANGE	80009	352-0165-03

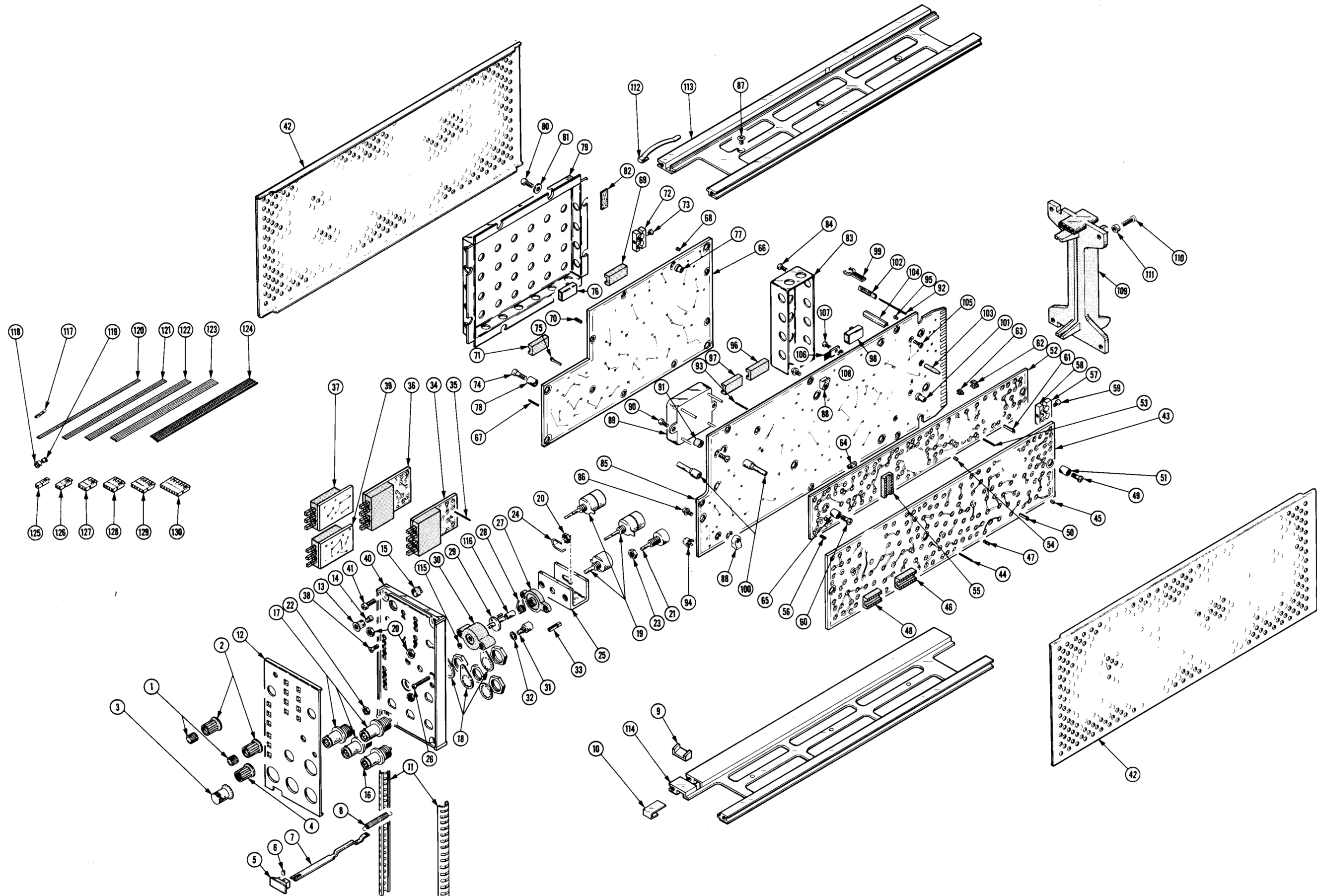

Fig. & Index No.	Tektronix Part No.	Serial/Model No. Eff	No. Dscont	Qty						Name & Description	Mfr Code	Mfr Part Number
					1	2	3	4	5			
070-1377-01				1						MANUAL,TECH:SERVICE	80009	070-1377-01

MANUAL CHANGE INFORMATION

At Tektronix, we continually strive to keep up with latest electronic developments by adding circuit and component improvements to our instruments as soon as they are developed and tested.

Sometimes, due to printing and shipping requirements, we can't get these changes immediately into printed manuals. Hence, your manual may contain new change information on following pages.

A single change may affect several sections. Since the change information sheets are carried in the manual until all changes are permanently entered, some duplication may occur. If no such change pages appear following this page, your manual is correct as printed.

SERVICE NOTE

Because of the universal parts procurement problem, some electrical parts in your instrument may be different from those described in the Replaceable Electrical Parts List. The parts used will in no way alter or compromise the performance or reliability of this instrument. They are installed when necessary to ensure prompt delivery to the customer. Order replacement parts from the Replaceable Electrical Parts List.

CALIBRATION TEST EQUIPMENT REPLACEMENT

Calibration Test Equipment Chart

This chart compares TM 500 product performance to that of older Tektronix equipment. Only those characteristics where significant specification differences occur, are listed. In some cases the new instrument may not be a total functional replacement. Additional support instrumentation may be needed or a change in calibration procedure may be necessary.

Comparison of Main Characteristics

DM 501 replaces 7D13		
PG 501 replaces 107	PG 501 - Risetime less than 3.5 ns into 50 Ω .	107 - Risetime less than 3.0 ns into 50 Ω .
108	PG 501 - 5 V output pulse; 3.5 ns Risetime.	108 - 10 V output pulse; 1 ns Risetime.
111	PG 501 - Risetime less than 3.5 ns; 8 ns Pretrigger pulse delay.	111 - Risetime 0.5 ns; 30 to 250 ns Pretrigger Pulse delay.
114	PG 501 - ± 5 V output.	114 - ± 10 V output. Short proof output.
115	PG 501 - Does not have Paired, Burst, Gated, or Delayed pulse mode; ± 5 V dc Offset. Has ± 5 V output.	115 - Paired, Burst, Gated, and Delayed pulse mode; ± 10 V output. Short-proof output.
PG 502 replaces 107		
108	PG 502 - 5 V output	108 - 10 V output.
111	PG 502 - Risetime less than 1 ns; 10 ns Pretrigger pulse delay.	111 - Risetime 0.5 ns; 30 to 250 ns Pretrigger pulse delay.
114	PG 502 - ± 5 V output	114 - ± 10 V output. Short proof output.
115	PG 502 - Does not have Paired, Burst, Gated, Delayed & Undelayed pulse mode; Has ± 5 V output.	115 - Paired, Burst, Gated, Delayed & Undelayed pulse mode; ± 10 V output. Short-proof output.
2101	PG 502 - Does not have Paired or Delayed pulse. Has ± 5 V output.	2101 - Paired and Delayed pulse; 10 V output.
PG 506 replaces 106	PG 506 - Positive-going trigger output signal at least 1 V; High Amplitude output, 60 V.	106 - Positive and Negative-going trigger output signal, 50 ns and 1 V; High Amplitude output, 100 V.
067-0502-01	PG 506 - Does not have chopped feature.	0502-01 - Comparator output can be alternately chopped to a reference voltage.
SG 503 replaces 190, 190A, 190B, 191, 067-0532-01	SG 503 - Amplitude range 5 mV to 5.5 V p-p. SG 503 - Frequency range 250 kHz to 250 MHz. SG 503 - Frequency range 250 kHz to 250 MHz.	190B - Amplitude range 40 mV to 10 V p-p. 191 - Frequency range 350 kHz to 100 MHz. 0532-01 - Frequency range 65 MHz to 500 MHz.
TG 501 replaces 180, 180A	TG 501 - Marker outputs, 5 sec to 1 ns. Sinewave available at 5, 2, and 1 ns. Trigger output - slaved to marker output from 5 sec through 100 ns. One time-mark can be generated at a time.	180A - Marker outputs, 5 sec to 1 μ s. Sinewave available at 20, 10, and 2 ns. Trigger pulses 1, 10, 100 Hz; 1, 10, and 100 kHz. Multiple time-marks can be generated simultaneously.
181	TG 501 - Marker outputs, 5 sec to 1 ns. Sinewave available at 5, 2, and 1 ns.	181 - Marker outputs, 1, 10, 100, 1000, and 10,000 μ s, plus 10 ns sinewave.
184	TG 501 - Marker outputs, 5 sec to 1 ns. Sinewave available at 5, 2, and 1 ns. Trigger output - slaved to marker output from 5 sec through 100 ns. One time-mark can be generated at a time.	184 - Marker outputs, 5 sec to 2 ns. Sinewave available at 50, 20, 10, 5, and 2 ns. Separate trigger pulses of 1 and .1 sec; 10, 1, and .1 ms; 10 and 1 μ s. Marker amplifier provides positive or negative time marks of 25 V min. Marker intervals of 1 and .1 sec; 10, 1, and .1 ms; 10 and 1 μ s.
2901	TG 501 - Marker outputs, 5 sec to 1 ns. Sinewave available at 5, 2, and 1 ns. Trigger output - slaved to marker output from 5 sec through 100 ns. One time-mark can be generated at a time.	2901 - Marker outputs, 5 sec to 0.1 μ s. Sinewave available to 50, 10, and 5 ns. Separate trigger pulses, from 5 sec to 0.1 μ s. Multiple time-marks can be generated simultaneously.

NOTE: All TM 500 generator outputs are short-proof. All TM 500 plug-in instruments require TM 500-Series Power Module.